

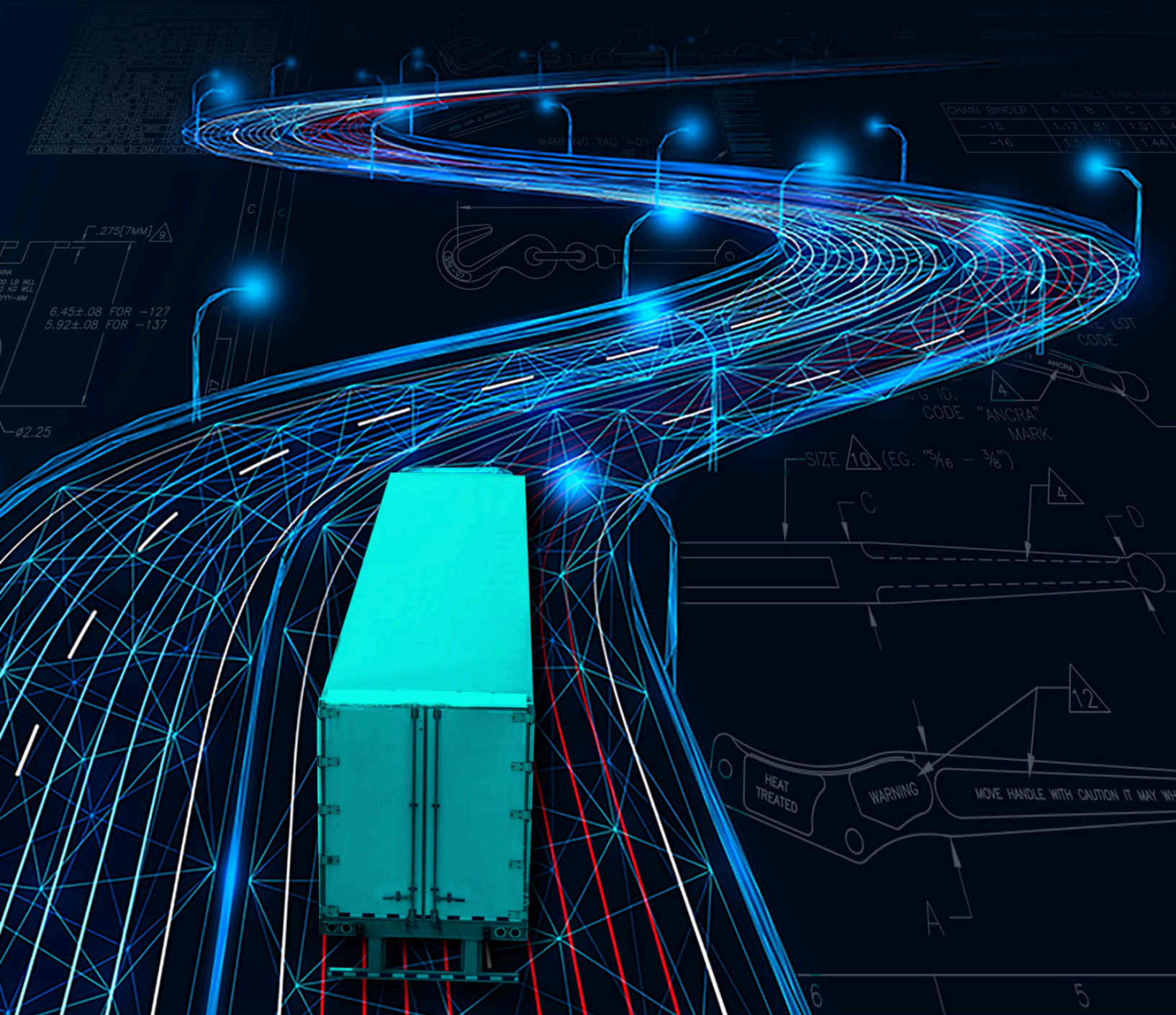

LEADER IN LOAD SECUREMENT INNOVATION



WWW.ANCRACARGO.COM

EVERYTHING YOU NEED FROM A TO Z TO MOVE ANYTHING FROM A TO B.

WELCOME TO OUR CATALOG.

From anchor points to zinc coated hardware and everything in-between, Ancra's world class cargo restraint systems equip you to take to the road with a stable, secure load. Whether your cargo calls for standard or heavy-duty restraint, in this comprehensive catalog you'll find dependable flatbed, interior van solutions, lifting slings, auto transport products, hardware, and utility tie downs to meet all your load securement requirements and help ensure your compliance with CSA.

THIS CATALOG IS ORGANIZED TO SAVE YOU TIME AND EFFORT.

There are eight major product sections:

- Flatbed
- Interior Van
- Safety and Emergency Equipment
- Auto Transport
- Lifting Slings
- Utility Tie Downs
- General Hardware & Webbing
- General Information

Color-coded pages in each section help you find the desired category quickly. All products are presented with photos and complete descriptions, capacities and sizes. **Drawings** and **sidebar how-tos** give you additional details, as well as **web links** and **Quick Response (QR) Codes** that connect you to dynamic online information.

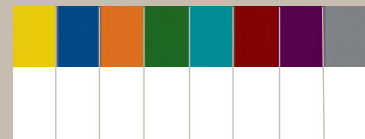

Trucker-Friendly Pages

If you're looking for a specific product, it's easy to find in our Index listings. Whether you're searching by part number or product name, you can find what you're looking for in our Numerical Index starting on page 112, or our Alphabetical Index on page 123.

Product pages offer comprehensive product information and more:

Trucker Tips:

Handy, helpful tips in boxes framed in black and yellow stripes.

Part Numbers:

Listed in boldfaced type followed by technical specifications.

Warnings:

Vital Information regarding product use or hazards on the road highlighted in color boxes.



Did you know?:

Facts and figures, historical industry notes stand out with their blue background.

QR Codes:

Quick Response icons when scanned on your smart phone can connect you to videos, demonstrations and details.

Links:

Take you to website pages for deeper information.

PAYMENT OPTIONS

AUTHORIZED DISTRIBUTORS CAN PAY BY CHECK, MONEY ORDER, OR WIRE OR BANK TRANSFER. YOU CAN OPEN A LINE OF CREDIT BY REQUESTING A CREDIT APPLICATION FROM OUR CUSTOMER SERVICE DEPARTMENT. AFTER THE SHORT APPROVAL PROCESS, YOU WILL BE READY TO PLACE YOUR ORDER.

HOW TO PLACE AN ORDER

ANCRA'S EXPERIENCED CUSTOMER SERVICE DEPARTMENT WILL HELP YOU WITH ALL QUESTIONS AND SPECIAL REQUESTS. YOU CAN CONTACT OUR STAFF TOLL FREE AT 1-800-929-2627. FAX ORDERS TO 1-800-347-2627, OR EMAIL CARGO-SALES@ANCRA.COM. ELECTRONIC ORDERING OPTIONS ARE AVAILABLE AS WELL.

SAFETY IN NUMBERS TIMES 3

Solid parent organization

Ancra Cargo has continuous access to professional services, financial and insurance partners and best practices policies, plus the further advantage of a solid parent organization, The Heico Companies, with annual sales approaching \$3-billion.

Safety factors

It doesn't take a numbers person to appreciate the built-in safety factor of reputable products. At Ancra, we use our own in-house testing facilities as well as independent sources to test and retest our securement products. It's a process that begins with initial design concepts and continues through the final manufacturing.

It doesn't end there. We constantly spot test finished products to make sure they meet quality cargo control standards day after day. We even test and evaluate products that have been in service for signs of corrosion and fatigue. When you see the working load limits permanently marked on Ancra winches, you can be sure those numbers will be met, and more.

In-service record

There's a third way we ensure safety in numbers. Serving the trucking industry for decades we have hundreds of thousands of reliable products working hard everyday. Truckers know what's good.

OUR SAFETY TESTING PROCESS



ABRASION TESTER CONFIRMS THE STRENGTH OF ANCRA STRAPS.

Random webbing samples are abrasion tested per ASTM D6770-097 then load tested for its ability to withstand accelerated wear.



TENSILE TEST EQUIPMENT CHECKS ANCRA WEBBING AND HARDWARE FOR LOAD CAPACITY USING UP TO 50,000 LBS. OF FORCE. If a product doesn't meet the minimum required capacity, the lot is rejected.

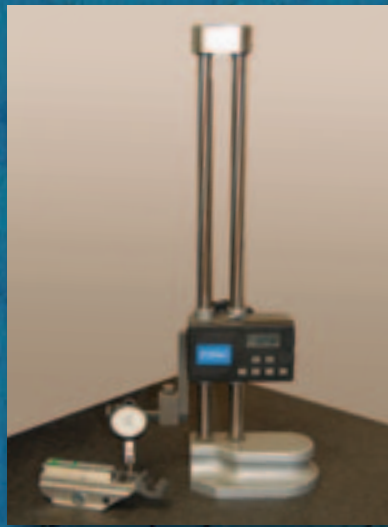

TOLERANCES. During the process of first article inspection, Ancra measures crucial tolerances with a granite table and height stand. This assures the product is built to design specs.



HIGH DEFINITION COMPARATOR verifies dimensions. Ancra products are inspected for accuracy and proper fit with mating parts that will assure trouble-free performance.

TABLE OF CONTENTS

COLOR-CODED PRODUCT SECTION

Flatbed Solutions

Web Winches	2, 3, 4, 5, 6
Combination Winches	7
Cable Winches	7
Lashing Winches	8
PortaWinch™ & Porta Anchor™	9
Winch Dimension Chart	10
Winch Track	11
SilverCap OverDrive® Ratcheting Cap	12
Ergo® Bars	13
Winch Bars and D-Rings	14
Hooks & Web Winders	15
GlideLock® and Coil Rack	16
Corner and Web Protectors	17, 18
X-Treme Guard®	18
Corner Protector Placement Tool	19
Tarp Ties, Rubber Rope & Hooks	20
Transport Chain & Hardware	21, 22, 23, 24, 25
EZ Binder®	26
Chain Load Binder & Accessories	26, 27
Floor Chain Tie Downs	27
Winch Strap Assemblies, X-TREME™	28, 29, 30
Winch Strap Assemblies, Standard	31, 32, 33
Roll On/Off Container Straps	33
Ratchet Strap Assemblies, X-TREME™	34, 35
Ratchet Strap Assemblies, Standard	36, 37, 38
Ratchet Strap Replacements	39, 40
Cable & Chain Anchors, X-TREME™	
Rope Tie Down, Toss 'N Tie™	41
5th Wheel Release Hook	42

Interior Van Solutions

AutoDeck®	44
Vers-A-Deck®	45
Lift-A-Deck® II	46, 47, 48, 49, 50, 51
Logist-A-Panel™	52
Poly Deckboard	52
Security Divider & Deckboard	53
Cart Securement System	53
Knock Down Pallet Deck	54
Pallet Deck	54
Retract-A-Roll® 2 & 4	55
Logistic Track	56, 57, 58
Beams, Bars & Hoops	59, 60
Shoring Bars	60
Beam Sockets	60
Cargo Sta®	61
Heavy-Duty Jack Bars	62
Cargo Bar Holder	63
Tie Offs	63
Door Pull Straps	63
Trailer Fittings	64
Releasable Trailer Door Strap	64
Trailer Door Limit Strap	65
Driver Assist Straps	65
Tension Limiting Ratchet Assemblies	66
Cam Buckle Strap Assemblies	67, 68

Plate Trailer Straps	68, 69
Ratchet Buckle Straps	69
Custom Nets	70

Safety and Emergency Equipment

Flag & Banners	72, 73
Reflectors	74
Wearables	74

Auto Transport Solutions

Car Hauler Straps	76
Car Tie Downs	77, 78
Dolly Straps	77
Transit Straps	77
Tire Bonnets	78
Lashing Winches	78

Lifting Solutions

Round Slings	80
Eye to Eye Web Slings	81, 82

Utility Tie Downs

Ratchet Strap Assemblies	84
Cam Strap Assemblies	84
Packaged Straps	85
Pickup Truck Cargo Nets	86

General Hardware & Webbing

Ratchet Buckles	88, 89, 90
Overcenter Buckles	90
Cam Buckles	91
Roller Buckle	91
3-Bar Slide Adjuster	91
Wire Hooks	92
Flat Hooks	93
Snap Hooks	94
Rings	94
Bolt Plates	95
Track Fittings	96, 97
Chain Attachments	97
Clevis Hooks	98
RTJ Cluster Hook	98
Chain Hardware	99, 100
Webbing	101
Heavy Duty Aircraft Style Track	102
Heavy Duty Beveled Aircraft Style Track	102
Merchandising	104

General Information

Specifications/Warranty	106
Industry Standards	107, 108
Replacement Criteria	109
Glossary	110
Trade Association, Resources	111
Index by Product Number	112
Index by Product Name	123

FLATBED SOLUTIONS

Ankra's trusted straps and high performance winches, tie downs, and chain assemblies are engineered to meet the challenges of today's highways. If it wears the Ankra name, it can be trusted.

- Long wearing heavy-duty components in every assembly
- Weather resistant, performance proven products
- Specially engineered construction for maximum durability
- Quick and easy operation
- Products to meet your most demanding applications
- Custom products available to meet your unique needs



FLATBED SOLUTIONS

SUPERIOR QUALITY

Ancra winches comply with FMCSA, WSTDA-T3 and Canadian Standard 905 regulations. Available in different base configurations to suit a variety of needs and load requirements.

All winches shown are right hand models. Left hand models may be available on special orders.

Black powder coat is the standard finish for all winches.

Smooth ground web slots prevent web wear.

Seamless solid steel mandrel.



Powder coating withstands 250 hours of standard salt spray testing to ensure years of service.

Stamped working load limit and Ancra name certify quality.

High-strength alloy pawl pins.

WEB WINCHES

Bottom Mount



43563-10

Standard Weld-on
Weight: 8.6 lbs./3.9 kg.
WLL: 5,500 lbs./2,500 kg.



43563-10-RW

Standard Weld-on Ratchet Winch
Weight: 10.1 lbs./4.58 kg.
WLL: 5,500 lbs./2,500 kg.

It is our recommendation that portable winches be removed from the trailer and stored when not in use. These style winches are secured to the trailer by the strap tension, not the set screws.



43564-127

Web Storable Portable w/ 2SS
Weight: 11.1 lbs./5.0 kg.
WLL: 5,500 lbs./2,500 kg.



43564-147

Standard Portable w/ 2SS
Lighter 7mm heat treated frame
Weight: 7.7 lbs./3.5 kg.
WLL: 5,500 lbs./2,500 kg.



43564-167

Low Profile Portable w/ 2SS
Weight: 10.1 lbs./4.58 kg.
WLL: 5,500 lbs./2,500 kg.



43573-10

Web Storable Weld-on
Weight: 9.1 lbs./4.1 kg.
WLL: 5,500 lbs./2,500 kg.

WEB WINCHES

Side Mount Weld-on

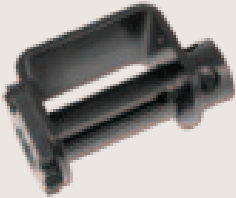

43579-20
Low Profile Weld-on
Weight: 7.3 lbs./3.3 kg.
WLL: 5,500 lbs./2,500 kg.



41691-10
Leg Bracket Weld-on
Weight: 7.1 lbs./3.2 kg.
WLL: 5,500 lbs./2,500 kg.

DID YOU KNOW? About Winches

3-BAR: Designed for easy strap insertion during snow and ice conditions. Prevents the mandrel from freezing up.

PORTABLE: Versatile and meant for temporary installation, and can be placed along the trailer side frame.

SPOOL: Designed to reduce strap wear, spool discs guide and store the webbing into a single roll up to 30'.

STANDARD DOUBLE CAP: Incremental adjustment from both sides of the winch allows for clearance applications.

SLIDERS: Allow for easy positioning in the track, but lock into place when tension is applied to the strap. For use with Ancra C track 42357-11, -12 & -21 and Ancra double L track 49242-10-120 & 49789-10-102 or equivalent.

Sliders



43565-127
Web Storable
C Track Slider.
Lighter 7mm heat treated frame
Weight: 8.2 lbs./3.7 kg.
WLL: 6,000 lbs./2,730 kg.



43565-127-RW
Web Storable Bottom Mount
Ratchet Winch
C Track Slider
Lighter 7mm heat treated frame
Weight: 9.7 lbs./4.4 kg.
WLL: 6,000 lbs./2,730 kg.



43565-127-XZ
Web Storable
X-Treme Zinc Finish
C Track Slider
Lighter 7mm heat treated frame
Weight: 8.2 lbs./3.7 kg.
WLL: 6,000 lbs./2,730 kg.



43565-137
Standard Double Cap
C Track Slider. Lighter 7mm heat
treated frame
Weight: 8.3 lbs./3.8 kg.
WLL: 6,000 lbs./2,730 kg.



43565-14
Web Storable w/ Side Washers
C Track Slider.
Weight: 8.6 lbs./3.9 kg.
WLL: 6,000 lbs./2,730 kg.
*43565-177 Standard height version also available.



Reduces weight per winch by 2 lbs. on average. Lighter weight reduces fuel expenses and allows for a greater payload. Heat treated material maintains strength.

FLATBED SOLUTIONS

WEB WINCHES

Sliders



43565-157

Standard Bottom Mount
C Track Slider. Lighter 7mm heat
treated frame
Weight: 7.6 lbs./3.5 kg.
WLL: 6,000 lbs./2,730 kg.



43565-157-RW

Standard Ratchet Winch
C Track Slider
Lighter 7mm heat treated frame
Weight: 9.1 lbs./4.1 kg.
WLL: 6,000 lbs./2,730 kg.



43565-157-XZ

Standard Bottom Mount
X-Treme Zinc Finish
C Track Slider
Lighter 7mm heat treated frame
Weight: 7.6 lbs./3.5 kg.
WLL: 6,000 lbs./2,730 kg.



49207-127

Web Storable
Double L Track Slider
Lighter 7mm heat treated frame
Weight: 6.8 lbs./3.09 kg.
WLL: 5,500 lbs./2,500 kg.



49207-127-XZ

Web Storable
Double L Track Slider
X-Treme Zinc Finish
Lighter 7mm heat treated frame
Weight: 6.8 lbs./3.1 kg.
WLL: 5,500 lbs./2,500 kg.

X-TREME[™] ZINC

*To give your winches
a longer working life,
specify X-Treme Zinc
for better corrosion
protection than zinc-
plated, paint or powder
coated finishes.*



49207-137

Standard
Double L Track Slider
Extended Pawl Feature
Lighter 7mm heat treated frame
Weight: 6.5 lbs./2.95 kg.
WLL: 5,500 lbs./2,500 kg.



49207-137-RW

Standard Ratchet Winch
Double L Track Slider
Lighter 7mm heat treated frame
Weight: 8.0 lbs./3.6 kg.
WLL: 5,500 lbs./2,500 kg.



49207-137-XZ

Standard
Double L Track Slider
X-Treme Zinc Finish
Extended Pawl Feature
Lighter 7mm heat treated frame
Weight: 6.5 lbs./2.3 kg.
WLL: 5,500 lbs./2,500 kg.

WEB WINCHES

Sliders

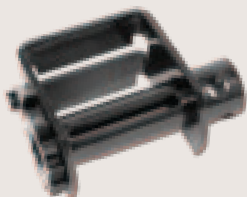

49207-187

Low Profile
Double L Track Slider
Lighter 7mm heat treated frame
Weight: 6.2 lbs./2.8 kg.
WLL: 5,500 lbs./2,500 kg.



49207-187-RW

Low Profile Ratchet Winch
Double L Track Slider
Lighter 7mm heat treated frame
Weight: 7.7 lbs./3.5 kg.
WLL: 5,500 lbs./2,500 kg.



49207-187-XZ

Low Profile
Double L Track Slider
X-Treme Zinc Finish
Lighter 7mm heat treated frame
Weight: 6.2 lbs./2.8 kg.
WLL: 5,500 lbs./2,500 kg.



49706-10

Standard
Wilson Track Slider
Weight: 12.5 lbs./5.7 kg.
WLL: 5,500 lbs./2,500 kg.

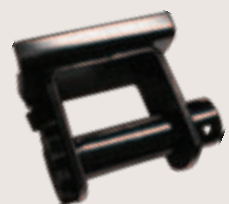

49246-10-BP

Standard
Utility Trailer Track Slider
Weight: 13 lbs./5.9 kg.
WLL: 5,500 lbs./2,500 kg.



PATENTED

RATCHETING WINCHES

Faster and more convenient than traditional winches. Reduces the tensioning time by 33%. Also, reduces risk of winch bar rollover. Once the winch bar tip is inserted into the winch cap, the winch can be fully tensioned without the need to repetitively remove and reposition the winch bar.

LOOSE TIE DOWNS?

Even with enough tie downs in place, if any are loose or defective, you could get a citation.

FLATBED SOLUTIONS

WEB WINCHES

3-Bar

Weld-on and 3-Bar winches are available in various finishes, including X-Treme Zinc.



48101-103
3-Bar Weld-on
Side Mount
Extended Pawl Feature
Weight: 9.5 lbs./4.3 kg.
WLL: 6,000 lbs./2,730 kg.

DID YOU KNOW?
Portable and slider winches are engineered to be placed anywhere along side the trailer as needed to best secure the load.

48101-143

3-Bar Standard Weld-on
Bottom Mount
Weight: 11.3 lbs./5.1 kg.
WLL: 6,000 lbs./2,730 kg.



48101-173

3-Bar Standard
C Track Slider
Weight: 10.4 lbs./4.7 kg.
WLL: 6,000 lbs./2,730 kg.



49207-273

3-Bar Standard
Double L Track Slider
Weight: 8.7 lbs./3.9 kg.
WLL: 5,500 lbs./2,500 kg.



49207-273-XZ

3-Bar Standard
Double L Track Slider
X-Treme Zinc Finish
Weight: 8.7 lbs./3.9 kg.
WLL: 5,500 lbs./2,500 kg.



49207-283-XZ

3-Bar Low Profile
Double L Track Slider
X-Treme Zinc Finish
Weight: 9.2 lbs./4.2 kg.
WLL: 5,500 lbs./2,500 kg.



49997-113

3-Bar Side Mount Bolt-on
Lighter 7mm heat treated frame
X-Treme Zinc Finish
Weight: 9.8 lbs./4.4 kg.
WLL: 5,500 lbs./2,500 kg.



COMBINATION WEB/CABLE WINCHES

Ancra Combination Winches are made in a variety of configurations to fit applications that require cable or webbing tie downs.



41681-10
Standard Bottom Mount
Extended Pawl Feature
Weight: 10.6 lbs./4.8 kg.
WLL: 5,500 lbs./2,500 kg.



43488-20
Low Profile Side Mount
Weight: 10.9 lbs./4.9 kg.
WLL: 5,500 lbs./2,500 kg.



43997-10
Low Profile Leg Bracket
Weight: 8.7 lbs./3.9 kg.
WLL: 5,500 lbs./2,500 kg.

CABLE WINCH

For cable applications, Ancra offers these popular models. Your cable selection must be consistent with your cable manufacturer's safe working load ratings.



END MOUNT

41696-10
End Mount RH
Weight: 15.4 lbs./7.0 kg.
WLL: 5,500 lbs./2,500 kg.

41696-11
End Mount LH
Weight: 15.4 lbs./7.0 kg.
WLL: 5,500 lbs./2,500 kg.



LASHING WINCHES

The lashing winch with double hex drive can be bolted or welded to the trailer like a standard winch, yet offers the quick release and easy operation of a ratchet buckle.

47640-31

With double hex drive and three mounting holes.

Weight: 3.8 lbs./1.7 kg.

WLL: 3,333 lbs./1,515 kg.

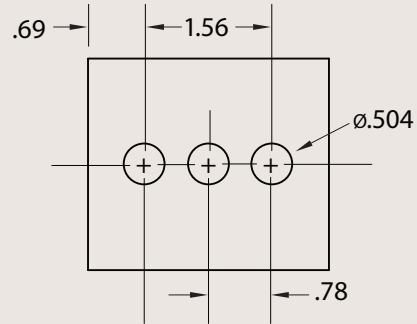
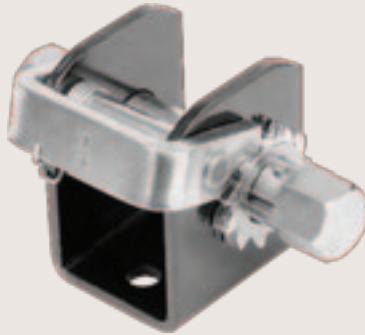

BEHOLD THE HUMBLE HERO

What would the trucking industry be today without the simple manually-operated winch? This ubiquitous device is centuries old, dating back to the Assyrians in the 5th century BC. During the Persian Wars, **Herodotus of Halicarnassus** described wooden winches that tightened the cables on a pontoon bridge. The Greeks were quick to adapt them for hauling and hoisting in construction. And today, winch uses range from tiny fishing reels to aircraft carrier anchor systems. The enduring technology is used on cranes, tow trucks, elevators and helicopters for lifting, hauling or simply securing.

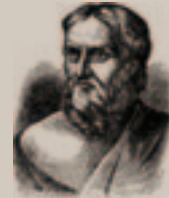

WINCHES HAVE LIMITS

Though winches don't actually come in contact with the load, their function of tightening and anchoring the webbing or cable is crucial to the security of over-the-road cargo hauling. Maintain these requirements for your safety and successful operation:

- ▶ The working load limit (WLL) is marked on the winch and shall not exceed one-third (1/3rd) of its breaking strength. Never exceed the working load limit (WLL) of any winch—it can result in severe personal injury or death. The winch design factor is based on destructive, laboratory-controlled testing conditions, which will not be exactly duplicated during actual loading conditions.
- ▶ The winch mandrel shall have a minimum of two (2) and a maximum of four (4) wraps of webbing.
- ▶ Use only winch bars designed for winch use to tension and release tie down assemblies.



- ▶ Use caution during tensioning to ensure the winch pawl fully engages into the sprocket before releasing pressure on the winch bar. Serious injury can occur if the pawl isn't properly engaged.

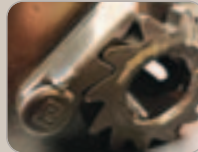

INSPECTION

To ensure winches perform properly, a quick inspection before each use will assure they are undamaged and in good working order. Damaged or non-operational winches should be replaced immediately.



CARE AND FEEDING

Winches are exposed to dirt, mud, snow, ice, road salt, etc. For optimal performance, they should be cleaned and lubricated to ensure the pawl will drop freely between the sprocket

teeth by gravity and the sprocket will rotate freely. When not in use, portable winches should be removed from the vehicle and stored in a dry location. With care, your winches will give you many miles.

TIME TO RETIRE

Repairing winches, components or winch track is not permitted. A winch should be removed from service when:

- ▶ The WLL is illegible
- ▶ Mandrel doesn't rotate freely when the pawl is released
- ▶ Pawl doesn't drop into the sprocket by gravity
- ▶ Excessive corrosion
- ▶ End cap is deformed and will not permit use of a winch bar
- ▶ Distorted, deformed, cracked, broken or malfunctioning components or welds
- ▶ Any other visible damage causing doubt to winch strength

PORTAWINCH® AND PORTAANCHOR®

PATENTED

Turn stake pockets into strap anchor points.

Ankra has created a way you can turn standard stake pockets into solid anchor points for securement straps. Our FMCSA compliant 3-Bar PortaWinch and PortaAnchor offer a versatile system that allows you to position the tie down straps anywhere along either side, front or back of the trailer, using stake pockets that best accommodate your load.

- ▶ Fasten straps securely and in compliance with federal regulations.
- ▶ Working Load Limit (WLL) 5,500 lbs./ 2,495 kg.
- ▶ For use with standard winch straps and tensions with standard winch bar.
- ▶ Fits all standard stake pockets. Will not fit tapered stake pockets.
- ▶ Installs easily without tools.
- ▶ Works over tires and toolboxes.
- ▶ Removable when not in use.



Installs easily with patented spring-loaded front hook design that distributes the load evenly across the stake pocket. Cap has four holes and accommodates standard winch bars.

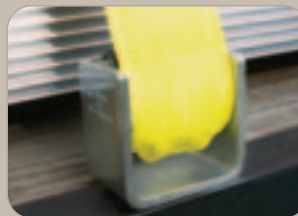

PortaAnchor accepts straps with flat hooks and straps with chain anchors.

PORTAWINCH® PATENTED

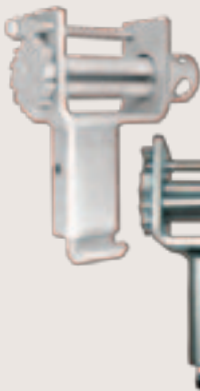

49716-10

Standard outward off-set.
Weight: 11.5 lbs./5.2 kg. WLL: 5,500 lbs.

49716-10-RW

Ratcheting PortaWinch
Standard outward off-set.
Weight: 13.2 lbs./5.9 kg. WLL: 5,500 lbs.

49716-11

Inward off-set to allow for track-mounted tarp clearance.
Weight: 11.5 lbs./5.2 kg. WLL: 5,500 lbs.

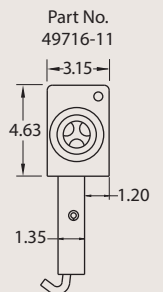
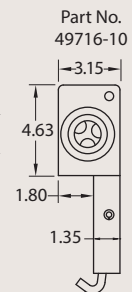
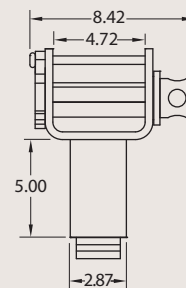

PORTAANCHOR® PATENTED



49717-10

Standard outward off-set.
Weight: 9.5 lbs./4.3 kg.
WLL: 5,500 lbs.

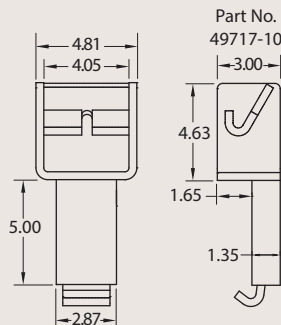

Flat Hook Application

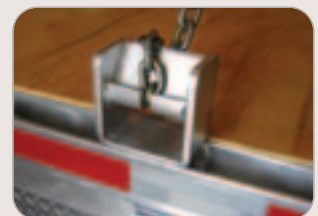

Chain Anchor Application

FLATBED SOLUTIONS

WINCH DIMENSIONS (inches)

Ancra Part No.	A Overall Width	B Inside Frame Width	C Frame Height	D Frame Depth	Ancra Part No.	A Overall Width	B Inside Frame Width	C Frame Height	D Frame Depth
41681-10	9.75	6.8	5.4	3.5	43997-10	10.3	7.2	5.0	3.9
41691-10	7.6	4.8	5.0	3.9	47640-31	5.9	2.1	4.0	3.0
41696-10	7.1	4.2	10.0	3.9	48101-103	8.6	4.8	4.3	4.0
41696-11	7.1	4.2	10.0	3.9	48101-143	8.6	4.8	5.5	4.0
43488-20	9.4	6.5	4.1	4.0	48101-173	8.5	4.8	6.1	4.0
43563-10	7.6	4.6	5.4	3.5	49207-127	7.5	4.6	6.6	4.0
43563-10-RW	8.6	4.6	6.6	4.0	49207-127-XZ	7.5	4.6	6.6	4.0
43564-12	7.6	4.6	6.2	3.5	49207-137	7.5	4.6	6.0	4.0
43564-147	7.3	4.6	5.5	3.5	49207-137-RW	8.0	4.6	6.0	4.0
43564-16	7.6	4.7	4.1	4.0	49207-137-XZ	7.5	4.6	6.0	4.0
43565-127	7.6	4.6	7.5	4.0	49207-187	7.5	4.6	5.3	4.0
43565-127-RW	10.0	4.6	7.5	4.0	49207-187-RW	8.0	4.6	5.3	4.0
43565-127-XZ	7.6	4.6	7.5	4.0	49207-187-XZ	7.3	4.6	5.3	4.0
43565-137	9.2	4.6	6.5	4.0	49207-273	8.6	4.9	5.7	4.0
43565-147	7.6	4.2	7.5	4.0	49207-273-XZ	8.6	4.9	5.7	4.0
43565-157	7.6	4.6	6.5	4.0	49207-283-XZ	8.6	4.9	4.7	4.0
43565-157-RW	8.0	4.6	6.5	4.0	49246-10-BP	7.6	4.6	6.5	3.5
43565-157-XZ	7.6	4.6	6.5	4.0	49706-10	7.9	4.9	6.5	4.0
43573-10	7.6	4.6	6.2	3.5					
43579-20	7.4	4.8	4.1	4.0					

Winch dimensions are subject to change.

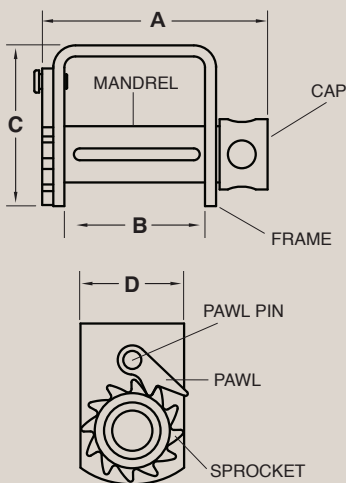

Winches are labeled with installation, maintenance and proper use instructions.

WINCH TRACK

Ankra winch track comes in two distinct styles:

- ▶ Standard C track, designed for use with the 43565 series C track slider winches, is available in roll-formed ¼" plate steel (42357-11), or aluminum (42357-21) for aluminum trailers.
- ▶ Double L aluminum track, designed for use with 49207 series slider winches, is available in standard depth (49242-10-120) and low profile (49789-10-120).

Custom lengths are available upon request. Winch track should be installed to meet the testing requirements of TTMA RP No. 47-03. For installation instructions, go to our website at <https://www.ancracargo.com/manuals/>, or just scan the QR Code.

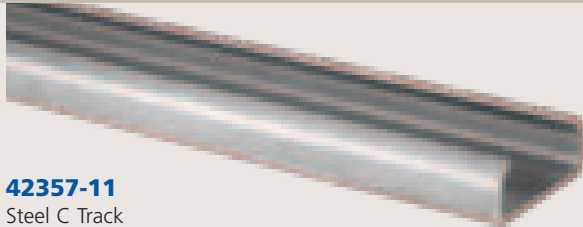

42357-11

Steel C Track
Weight: 39.0 lbs./17.73 kg. Length: 6'

42357-12

Steel C Track
Weight: 78.0 lbs./35.4 kg. Length 12'

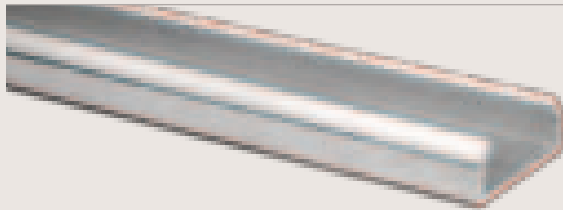
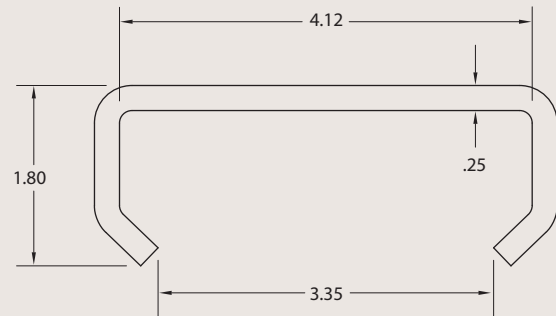

42357-21

Aluminum C Track
Weight: 19.0 lbs./8.64 kg. Length: 6'

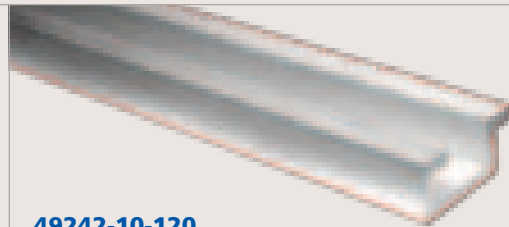
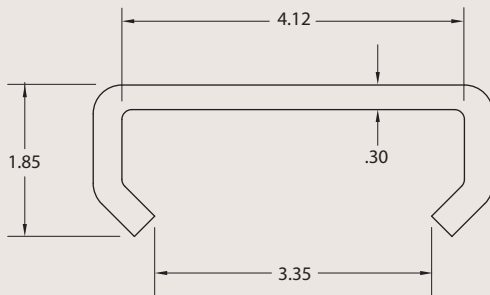

49242-10-120

Aluminum Double L Track
Weight: 20.9 lbs./9.5 kg. Length: 10'

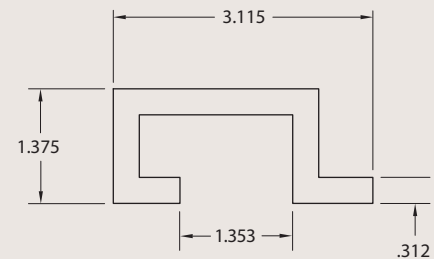

49789-10-120.00

Low Profile Aluminum Double L Track
Weight: 16.83 lbs./7.64 kg. Length: 10'

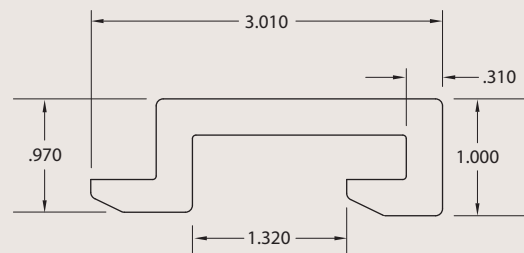

SILVERCAP OVERDRIVE® RATCHETING CAP

PATENTED

Convert any winch into a ratcheting winch by adding Ancra's OverDrive Ratcheting Cap. The OverDrive Ratcheting Cap has been re-engineered to feature the enhanced ratcheting mechanism employed by all Ancra Ratcheting Winches. Benefits of the OverDrive Ratcheting Cap include an easy access grease fitting for maintaining effortless function and ease of installation onto standard winches using the hardware provided. The patented design includes internal seals to keep out moisture and road grime so an outer rubber sleeve is no longer needed. Your winch bar stays in the winch until your straps are tight. For more information about Ancra's one-year product warranty, please call Customer Service at 800-233-5138.



SilverCap
OverDrive



Ancra's OverDrive® is the easy upgrade for winches. With a ratcheting winch, you work faster because the winch bar stays in the winch until the strap is tight.

To install on any winch:

1. Simply slide the OverDrive unit over the cap of the existing winch.
2. Rotate cap to line up holes and insert pin.
3. Secure it with the bolt.

It's that simple. All necessary parts are included.



49723-10

Weight: 3.45 lbs./1.56 kg.

Assembly Diagram

Lubrication: Periodically add lubricant through grease fitting to maintain ratchet function. Use needle adapter on grease gun. Shell Gadus S2 V100 is recommended. **DO NOT OVERFILL.**

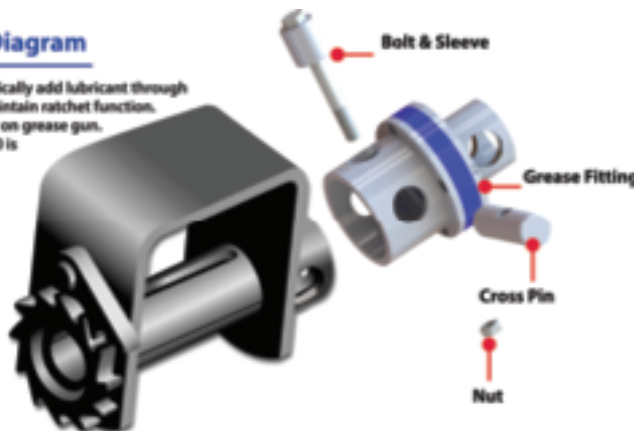

FLATBED ACCESSORIES

Ergo 360° Winch Bars

PATENTED



See what a difference a bend in the bar makes.

The Ergo 360° Bar raised winch bars to a new level with a patented ergonomic design that maintains parallel alignment of handle and tip. You can rotate the bar for optimum leverage without removing it, secured in the winch cap through the mushroom tip. Easy to carry and handle, the Ergo 360° is available in standard, combination and combination box end models. Combination bars can be used to release tension on chain binders. Use caution to avoid injury. Not to be used as a cheater bar.

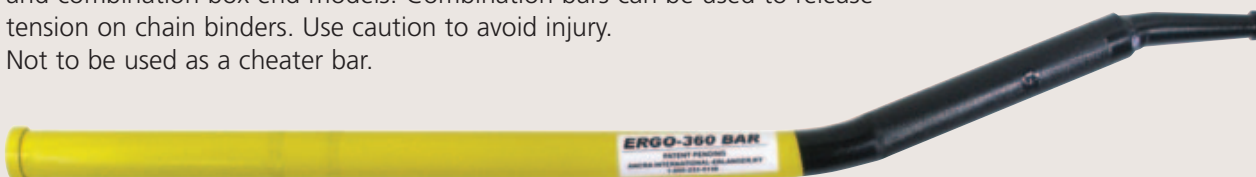

50015-10
Standard Painted.
Weight: 5.0 lbs./2.27 kg.



50015-20
Combination Painted.
Weight: 6.5 lbs./2.95 kg.



50015-21
Combination Box End Painted.
Weight: 6.0 lbs./2.72 kg.



Learn how this uniquely designed winch bar prevents injuries. Scan this QR Code to watch the video or go to our website at <https://www.ancracargo.com/winch-bars/c/386>

FLATBED SOLUTIONS

FLATBED ACCESSORIES

Standard Winch Bars

Tapered and angled at the end for easy operation, Ancra's winch bar handles are knurled at two sections, and the mushroom tip helps keep the bar from slipping from the winch cap. They are heat-treated for extra strength and cycle tested to simulate years of heavy use. Combination winch bars can be used to release tension on chain binders. Use caution to avoid injury. Not to be used as a cheater bar.

Flanged mushroom tip helps keep the bar from slipping from the winch cap.



42313-10
Standard Painted. Weight: 5.0 lbs./2.27 kg.



42313-17
Standard Chrome. Weight: 5.0 lbs./2.27 kg.

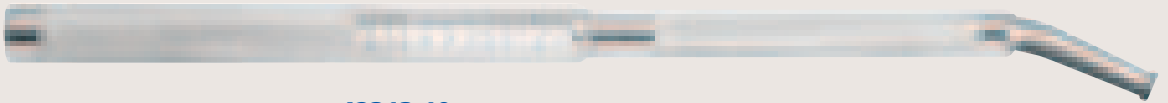

42313-19
Combination Chrome. Weight: 6.5 lbs./2.95 kg.



42313-12
Combination Box End Painted Silver and Yellow. Weight: 6.5 lbs./2.95 kg.

Heavy Duty D-Rings



Rugged forged steel D-Rings add versatility for securing complex loads. Utility trailers typically use 1/2 and 5/8 inch models, while heavy-duty applications rely on the 3/4 and 1-inch sizes. Individually polybagged.

49896-10 **NEW**
1/2" Forged steel w/
Bolt-on clip
(Galvanized)
Wt: 1.0 lbs./50 kg.
WLL: 4,000 lbs.

49896-11 **NEW**
1/2" Forged steel w/
Weld-on clip
(Galvanized)
Wt: 1.0 lbs./50 kg.
WLL: 4,000 lbs.

49897-10 **NEW**
5/8" Forged steel w/
Weld-on clip
(Galvanized)
Wt: 1.9 lbs./86 kg.
WLL: 6,300 lbs.

49898-10 **NEW**
3/4" Forged steel w/
Weld-on clip
(Galvanized)
Wt: 2.2 lbs./1.0 kg.
WLL: 9,000 lbs.

49899-10
1" Forged steel w/
Weld-on clip
Wt: 4.4 lbs./2.0 kg.
WLL: 15,600 lbs.

49899-11
1" Forged Bent D-Ring
Assembly w/ Weld-on
clip. Wt: 4.8 lbs./2.1 kg.
WLL: 15,600 lbs.

FLATBED ACCESSORIES

Hooks & Web Winders

44102-11

H-2 Hook. Flame-cut from 5/8-in. material and can be welded on vehicles. Accepts web loops, D-Rings, cable or rope. Meets anchorage requirements when properly secured. Hook opening .81" Weight: .61 lb./ .28 kg. WLL: 5,400 lbs./2,450 kg.

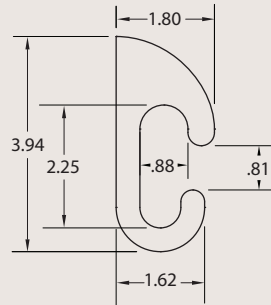

44122-10

Corner Iron Hook
Constructed with no sharp corners to reduce abrasion to rope or cable.
Weight: .63 lb./ .29 kg.



50024-10

Tarp Hook. For securing tarp straps to trailers.
1/2-in. steel wire.
Unfinished light oil.
Weight: .39 lb./ .18 kg.

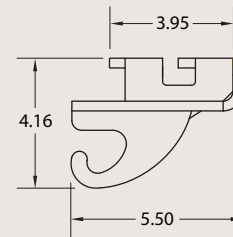

49768-10

Double L Track Slider Hook
Black powder coat finish.
Hook opening .71"
Weight: 5.65 lbs./2.57 kg.
WLL: 5,500 lbs./2,500 kg.



50092-10

EZ Winder Strap Winder quickly and easily winds webbing onto your winch for storage.
Weight: 1.1 lbs./ .5 kg.



45801-10

Web Winder. Constructed of all steel, the Ankra Web Winder winds 2-in., 3-in. and 4 in. winch straps for compact storage. Easy to attach to vehicle rails, easy to remove with tapered forks, and easy to disassemble for storage.
Weight: 3.25 lbs./1.48 kg.



50391-10

Premium Cargo Strap Winder
Constructed of zinc-plated steel for maximum durability, the new Strap Winder quickly assists in winding winch straps into rolls for storage. Designed to clip into trailer stake pocket or side rail.
Weight: 2.7 lbs./1.2 kg.



Heavy Duty Strap Storage Band

Keep stored straps from unrolling with our 1-inch by 7-inch long storage bands. Made of natural rubber, the storage bands are tough and easy-to-use at low temperatures.

50433-10 Pack of 5



FLATBED SOLUTIONS

FLATBED ACCESSORIES

GlideLock® Double L Track Flat Hook Sliding Bracket



Lock and load with GlideLock® movable securement bracket for double L track

GlideLock Sliding Load-Securement Bracket offers versatility and positioning of tie down anchor point. Once the flat hook is engaged, the unit locks the hook in position. It cannot shift or come undone, it remains secure until you unlock it. Meets Federal Motor Safety Administration (FMCSA) standards.

Provides a sliding positive attachment point for flat hooks in double L track.



50722-10

GlideLock for Double L Track
WLL: 5,400 lbs./2,450 kg.
Weight 4.50 lbs./2.04 kg

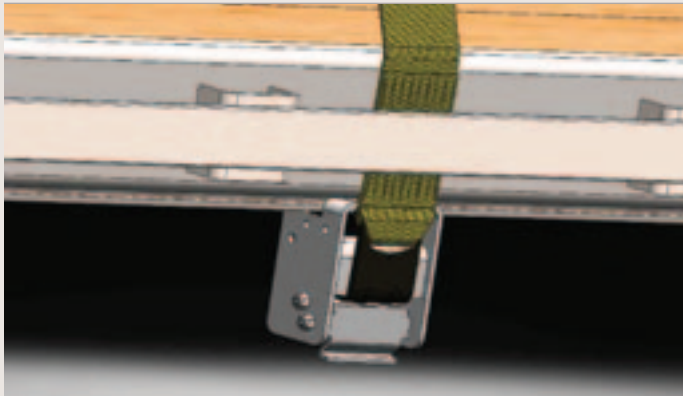

How GlideLock Works

With a Working Load Limit of 5,400 lbs., GlideLock glides into any position along the trailer rail or winchtrack to ensure the correct pull-angle for securing cargo. The compact unit keeps the strap inboard of the rub rail and works with any standard flat-hook strap.

Coil Racks

Our coil racks are designed to aid in supporting steel coils on flatbed trailers. Available for both light and heavy duty applications. Used with lumber blocks which provide extra cradling of the coils. Both have a black lacquer finish. New D.O.T. standards specifically address securement of metal coils. When chocks are used, they must be held in place by coil bunks or racks to prevent them from coming loose.

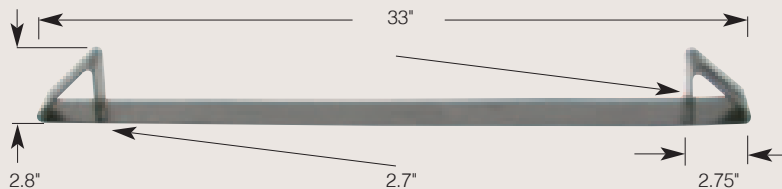
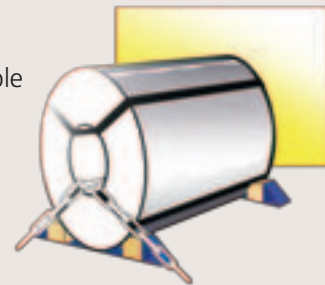

49344-10

Standard Duty
Metal Gauge: 10
Weight: 5.7 lbs./2.60 kg.

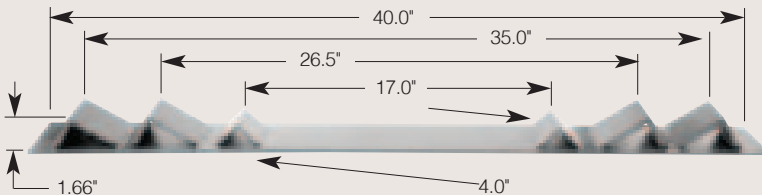

49344-12

Heavy-Duty 1/4" steel sheet per
ASTM A36
Weight: 16.75 lbs./7.6 kg.

FLATBED ACCESSORIES

Corner Protectors

Along with our standard rugged flatbed products, Ancra accessories offer high performance and durability. Sturdy corner and web protectors prevent abrasion of cargo and cargo-securing straps. **Corner Protectors not to be used as sling protection for overhead lifting.**



43986-10

High Density Polymer
Suitable for webbing up to 4".
5.25" wide and extends approx.
3.5" to protect the load. **Has
excellent low temperature
performance, down to -20°F.**
Weight: .06 lb./0.03 kg.

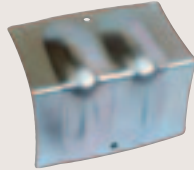

49377-10

Steel (Zinc Plated)
For use with chain and extends
4" to protect the load.
Weight: 1.10 lbs./0.50 kg.



49377-11

Rubber coated Steel
For use with chain and extends
4" to protect load.
Weight: 1.9 lbs./0.86 kg.



49577-10

Steel (Galvanized)
For use with chain. 4" wide
and extends 3" on top and
3.5" to protect the load.
Weight: .90 lb./0.41 kg.

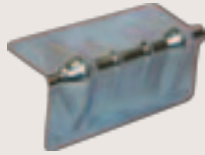

49756-10

Steel Corner Protector for chain and up to 4"
winch straps and extends 3-5/8" to protect the
load. Weight: 1.26 lbs./0.57 kg.



49584-10

12" Long Plastic. Extends approx. 3" to protect
the load. Suitable for webbing up to 4" in width.
**Has excellent low temperature performance,
down to -20°F.** Weight: .47 lb./0.21 kg.



42098-12

Extends approx 5" to protect the load
for webbing up to 4" in width.
Weight: .75 lb./0.34 kg.

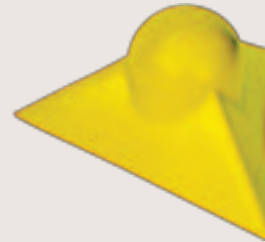

49913-10

Tarp Protector. Yellow plastic.
Weight: .21 lb./0.09 kg.

Web Protector



40985-05-12

12-in. Cordura® Nylon sleeve for 2-in.
webbing. Weight: .13 lb./0.06 kg.

40985-05-RL

100-yd. bulk roll Cordura Nylon sleeve
for 2-in. webbing. Weight: .39 lb./yd./
.18 kg./meter. Cordura® is a registered
trademark of Dupont.

FMCSA Cargo Securement Standard, Section 393.104 (f)4

*Edge protection must be used
whenever a tiedown would be
subject to abrasion or cutting at
the point where it touches an
article of cargo. The edge
protection must resist abrasion,
cutting and crushing.*

FLATBED SOLUTIONS

FLATBED ACCESSORIES

X-TREME GUARD® PROTECTS YOUR LOAD AND YOUR STRAPS



14"



24"



39"

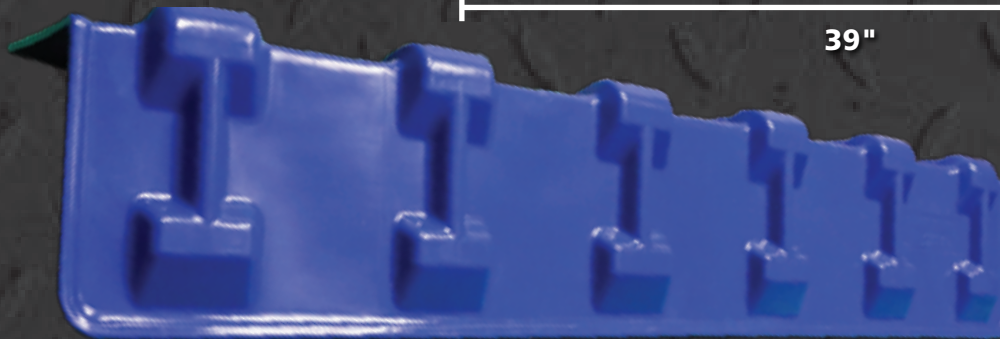

48"

Ankra's new high-density polyethylene X-TREME GUARD™ Corner Protector distributes strap tension over the length of the guard to prevent your cargo from being crushed by the straps and protects your webbing from abrasion. Made in lengths of 14, 24, 39, and 48-inches, this durable guard is strong yet lightweight, and crack/weather resistant to -30°. The different rib spacing allows for various strap widths and helps to stack protectors more efficiently.

Corner Protectors not to be used as sling protection for overhead lifting.



50089-12	14" length, Weight: 1.53 lbs/.69 kg.
50089-24	24" length, Weight: 2.37 lbs/1.07 kg.
50089-39	39" length, Weight: 3.97 lbs/1.8 kg.
50089-48	48" length, Weight: 4.65 lbs/2.1 kg.

FLATBED ACCESSORIES

Corner Protector Placement Tool



Now there's no need to climb onto the load to position a corner protector on the top corners of your flatbed trailer cargo.

Stand firmly on the ground with Ancra's Corner Protector Placement Tool, a lightweight, telescoping tool with powder-coated steel handle and impact-resistant durable head that has a recessed center that repositions cargo straps over the load. The Placement Tool works with the X-Treme Guard corner protectors as well as most other Ancra corner protectors, including: 43986-10, 49377-10, 49377-11, 49756-10 and 49584-10.

50451-11 Corner Protector Placement Tool
Extension Pole: 4ft.– 8ft. Weight: 4.2 lbs./1.57 kg.

Rubber Rope & Hooks

- Standard 150-ft. coils
- Easily assembled to desired length for application.



49454-11
3/8" Solid Core Rubber Rope
Weight: 7.4 lbs./3.35 kg.

49454-13
7/16" Solid Core Rubber Rope
Weight: 10.7 lbs./4.86 kg.



49211-10
Rubber Rope Hook
100 per pack
Weight: 5.2 lbs./2.37 kg.

HOW TO ATTACH HOOK TO RUBBER ROPE

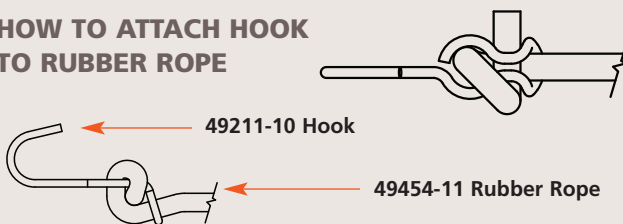

FLATBED ACCESSORIES

Top Premium Brand Tarp Ties



In the heavy duty trucking industry, Goldline® Heavy Duty EPDM Tarp Ties have been a favorite with fleets and independent owners for 45 years.

Made in the USA and known for quality, durability, and resistance to the elements, these tarp ties offer good stretch recovery and maintain their strength over the entire life of the tarp ties. The two lines include the longest lasting, larger cross section Goldline® Heavy Duty EPDM tarp ties best recognized by truckers, and the standard cross section Ancra EPDM Tarp Ties. Our natural rubber tarp ties are best suited for colder climates and are our most economical offering. Ancra's tarp tie offering provides you the customer with product options that can be chosen and suited to your application.

- ▶ Quantity 50 per box
- ▶ Designed to hold tarp covers on trucks and trailers
- ▶ Not to be used to restrain or secure cargo
- ▶ Molded EPDM construction for high Ozone resistance and strength resiliency or molded natural rubber for good cold weather stretch properties
- ▶ Wear safety glasses and use caution when using tarp ties
- ▶ **WARNING: SUDDEN RUPTURE OR DISCONNECT WHILE IN STRETCHED POSITION CAN CAUSE SERIOUS INJURY**

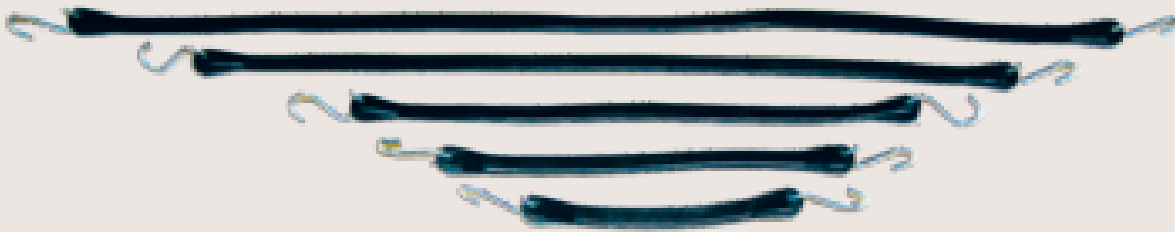

52210GL

Goldline HD EPDM made in the USA-10"

52215GL

Goldline HD EPDM made in the USA-15"

52221GL

Goldline HD EPDM made in the USA-21"

52231GL

Goldline HD EPDM made in the USA-31"

52241GL

Goldline HD EPDM made in the USA-41"



52210AE

Ancra EPDM Tarp Ties-10"

52215AE

Ancra EPDM Tarp Ties-15"

52221AE

Ancra EPDM Tarp Ties-21"

52231AE

Ancra EPDM Tarp Ties-31"

52241AE

Ancra EPDM Tarp Ties-41"

NATURAL RUBBER

Crimped Ends

52210C

Natural Rubber Tarp Tie-10"

52215C

Natural Rubber Tarp Tie-15"

52221C

Natural Rubber Tarp Tie-21"

52231C

Natural Rubber Tarp Tie-31"

52241C

Natural Rubber Tarp Tie-41"

GRADE 70 'TRANSPORT' CHAIN

Grade 70 chain was designed specifically to provide a light yet strong chain for tie downs. Made from heat treated carbon steel and zinc plated gold chromate for corrosion resistance. Chains are 100% proof tested to 2X WLL rating. Made to NACM standards per specifications of the FMCSA & CCMTA for tie down use. All clevis hooks are made of heat treated alloy steel.



BROWN BARREL
1/4-in. Chain



ORANGE BARREL
5/16-in. Chain



GREEN BARREL
3/8-in. Chain



RED BARREL
1/2-in. Chain

Grade 70 Chain Assemblies with Clevis Hooks



- 45881-10-16** 5/16-in. x 16-ft. WLL: 4,700 lbs./2,130 kg. Weight: 17.4 lbs./7.89 kg.
10 Assemblies per Orange Barrel
- 45881-10-20** 5/16-in. x 20-ft. WLL: 4,700 lbs./2,130 kg. Weight: 21.7 lbs./9.90 kg.
10 Assemblies per Orange Barrel
- 45881-10-25** 5/16-in. x 25-ft. WLL: 4,700 lbs./2,130 kg. Weight: 26.7 lbs./12.10 kg.
10 Assemblies per Orange Barrel
- 45881-11-16** 3/8-in x 16-ft. WLL: 6,600 lbs./2,990 kg. Weight: 24.4 lbs./11.08 kg.
10 Assemblies per Green Barrel
- 45881-11-20** 3/8-in. x 20-ft. WLL: 6,600 lbs./2,990 kg. Weight: 30.4 lbs./13.80 kg.
10 assemblies per Green Barrel
- 45881-11-25** 3/8-in. x 25-ft. WLL: 6,600 lbs./2,990 kg.. Weight: 39.0 lbs./17.71 kg.
10 Assemblies per Green Barrel
- 45881-13-20** 1/2-in x 20-ft. WLL: 11,300 lbs./5,130 kg. Weight: 53.6 lbs./24.33 kg.
5 Assemblies per Red Barrel
- 45881-13-25** 1/2-in. x 25-ft. WLL: 11,300 lbs./5,130 kg. Weight: 66.2 lbs./30.05 kg.
5 Assemblies per Red Barrel

Grade 70 Bulk Chain



- 45880-12** 1/4-in. x 400-ft. WLL: 3,150 lbs./1,430 kg. Weight: 262 lbs./118.9 kg.
Brown Barrel
- 45880-10** 5/16-in x 400-ft. WLL: 4,700 lbs./2,130 kg. Weight: 408 lbs./185 kg.
Orange Barrel
- 45880-11** 3/8-in. x 200-ft. WLL: 6,600 lbs./2,990 kg. Weight: 296 lbs./134.4 kg.
Green Barrel
- 45880-13** 1/2-in x 100-ft. WLL: 11,300 lbs./5,130 kg. Weight: 251 lbs./114 kg.
Red Barrel

GRADE 70 'TRANSPORT' CHAIN

XHD™ 3/8" Chain Assemblies

The extreme heavy duty performance of G70 chain with the added strength and size of our G80 clevis hooks. Each part is heat treated and proof tested to twice the Working Load Limit. All chain assemblies are made to NACM standards and comply with the specifications of the FMCSA and CCMTA for tie down use.

- ▶ Available in 10' and 20' lengths
- ▶ G70 carbon steel, zinc plated, alloy chain with gold chromate finish
- ▶ G80 forged alloy hooks with 19% more material in the neck of the hook
- ▶ Individually packaged for resale inside color coded barrels

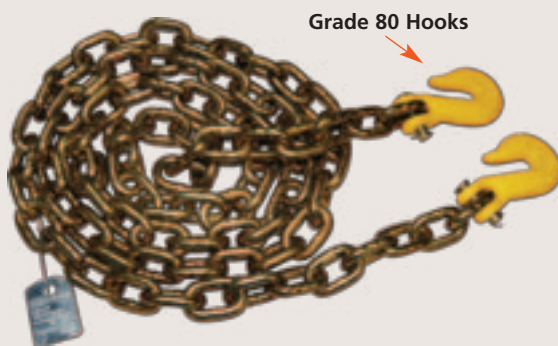

50364-38-10

Length: 10-ft./3.0m
WLL: 6,600 lbs./3,000 kg.
Weight: 17 lbs./7.7 kg.

50364-38-20

Length: 20-ft./6.0m
WLL: 6,600 lbs./3,000 kg.
Weight: 31 lbs./14.5 kg.

Packaged Transport Chain In A Pail

Packaged Grade 70 transport chain assemblies are offered in a convenient storage pail to keep organized in your tool box or vehicle. Grade 70 chain is specifically designed to provide a light, yet strong chain for tie downs. Made from carbon steel, heat treated for strength and zinc plated gold chromate for corrosion resistance. Made to NACM standards to meet the specifications of the FMCSA & CCMTA for tie down use. All clevis hooks are made of heat-treated alloy steel.



45881-10-16-SP 5/16-in x 16-ft. WLL: 4,700 lbs./2,130 kg. Weight: 18.8 lbs./8.52 kg.

45881-10-20-SP 5/16-in x 20-ft. WLL: 4,700 lbs./2,130 kg. Weight: 23.4 lbs./10.61 kg.

45881-10-25-SP 5/16-in x 25-ft. WLL: 4,700 lbs./2,130 kg. Weight: 28.3 lbs./12.83 kg.

45881-11-16-SP 3/8-in x 16-ft. WLL: 6,600 lbs./2,990 kg. Weight: 25.8 lbs./11.71 kg.

45881-11-20-SP 3/8-in x 20-ft. WLL: 6,600 lbs./2,990 kg. Weight: 31.9 lbs./14.48 kg.

45881-11-25-SP 3/8-in x 25-ft. WLL: 6,600 lbs./2,990 kg. Weight: 40.5 lbs./18.39 kg.

GRADE 70 CLEVIS HOOKS

Forged from high strength alloy steel, Ancra clevis hooks are made for Grade 70 chain. Sized from 1/4" to 1/2", the chain hooks are heat treated for strength and durability. Each hook is marked with manufacturer ID and chain size and grade in compliance with the NACM Chain Hook Standard. Hooks are proof tested to twice their WLL rating and have 4:1 design factor to meet the NACM hook strength requirements.

Forged steel hook, zinc plated gold chromate finish. Individually polybagged with clevis pin and cotter pin included.

- 45946-12** 1/4-in. Clevis Hook WLL: 3,150 lbs./1,430 kg. Weight: .40 lbs./.18 kg.
- 45946-10** 5/16-in. Clevis Hook WLL: 4,700 lbs./2,130 kg. Weight: .85 lbs./.39 kg.
- 45946-11** 3/8-in. Clevis Hook WLL: 6,600 lbs./2,990 kg. Weight: 1.10 lbs./.5 kg.
- 45946-13** 1/2-in. Clevis Hook WLL: 11,300 lbs./5,130 kg. Weight: 2.10 lbs./1.04 kg.

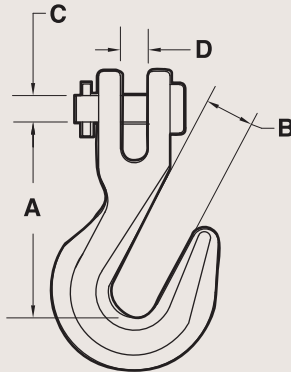

DIMENSION TABLE				
	A	B	C	D
45946-12	2.00	.40	.31	.36
45946-10	2.30	.43	.38	.38
45946-11	2.70	.50	.48	.44
45946-13	3.20	.66	.63	.75

Replacement G70 Clevis Pin

High strength steel replacement clevis pins are designed to meet the strength requirements of Grade 70 hooks and their heads are marked G7 or 70.

- 50412-100** Packaged Kit Includes one zinc plated clevis pin and cotter pin for a 5/16 Grade 70 chain hook. Weight: .17 lb./.07 kg.
- 50412-102** Packaged Kit Includes one zinc plated clevis pin and cotter pin for a 3/8 Grade 70 chain hook. Weight: .22 lb./.09 kg.
- 50412-103** Packaged Kit Includes one zinc plated clevis pin and cotter pin for a 1/2 Grade 70 chain hook. Weight: .23 lb./.10 kg.

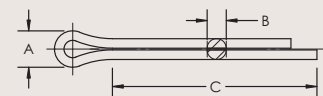
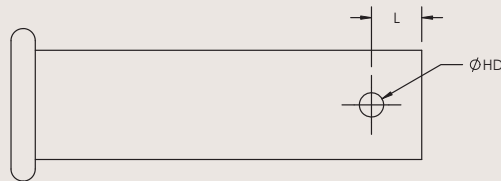
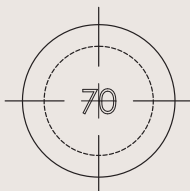

WARNING:

- DO NOT EXCEED RATED WORKING LOAD LIMIT (WLL) CAPACITY
- NOT TO BE USED FOR OVERHEAD LIFTING OR PULLING
- USE WITH LOAD BINDERS OF EQUAL OR HIGHER WLL RATINGS
- INSPECT BEFORE EACH USE. DO NOT USE IF CRACKED, BENT OR WORN.

FLATBED SOLUTIONS

CHAIN HARDWARE

We offer a wide selection of chain hardware for popular applications — from zinc plated clear chromate anchor shackles in screw pin and clevis pin models to Quick Links in various sizes. Corrosion resistant, zinc plated gold chromate Grade 70 Twin Clevis and Slip Hooks come in a wide range of sizes, with and without safety latches.

Screw Pin Anchor Shackle — Galvanized and individually polybagged

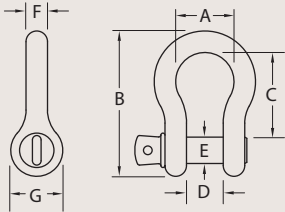

PART NUMBER	SIZE	WEIGHT	WLL
50013-31	5/16-in.	.18 lbs./08 kg.	1,500 lbs./681 kg.
50013-38	3/8-in.	.30 lbs./14 kg.	2,000 lbs./900 kg.
50013-44	7/16-in.	.49 lbs./22 kg.	3,000 lbs./1,362 kg.
50013-50	1/2-in.	.74 lbs./34 kg.	4,000 lbs./1,816 kg.
50013-63	5/8-in.	1.44 lbs./65 kg.	6,500 lbs./2,951 kg.
50013-75	3/4-in.	2.16 lbs./98 kg.	9,500 lbs./4,313 kg.
50013-88	7/8-in.	3.37 lbs./1.52 kg.	13,000 lbs./5,896 kg.
50013-100	1-in.	5.30 lbs./2.4 kg.	17,000 lbs./7,711 kg.

	A	B	C	D	E	F	G
50013-31	.81	2.25	1.25	.53	Ø3/8	Ø.31	1.00
50013-38	.94	2.61	1.44	.66	Ø7/16	Ø.38	1.13
50013-44	1.06	3.01	1.69	.72	Ø1/2	Ø.44	1.25
50013-50	1.19	3.34	1.88	.81	Ø5/8	Ø.50	1.38
50013-63	1.50	4.04	2.41	1.06	Ø3/4	Ø.63	1.88
50013-75	1.75	5.04	2.84	1.25	Ø7/8	Ø.75	2.13
50013-88	2.00	5.86	3.31	1.44	Ø1.00	Ø.75	2.38
50013-100	2.31	6.63	3.75	1.69	Ø1.13	Ø.75	2.63

Clevis Pin Anchor Shackle — Galvanized and individually polybagged

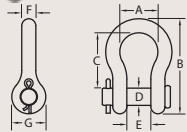

PART NUMBER	SIZE	WEIGHT	WLL
50014-50	1/2-in.	.74 lbs./34 kg.	4,000 lbs./1,816 kg.
50014-63	5/8-in.	1.44 lbs./65 kg.	6,500 lbs./2,951 kg.

	A	B	C	D	E	F	G
50014-50	1.19	3.39	1.88	Ø5/8	.81	Ø.50	1.38
50014-63	1.50	4.17	2.41	Ø3/4	1.06	Ø.63	1.88

Quick Links — Zinc plated clear chromate and individually polybagged

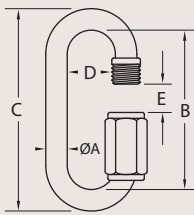

PART NUMBER	SIZE	WEIGHT	WLL
50016-25	1/4-in.	.062 lbs./028 kg.	880 lbs./399 kg.
50016-31	5/16-in.	.154 lbs./07 kg.	1,760 lbs./799 kg.
50016-38	3/8-in.	.198 lbs./90kg.	2,200 lbs./998 kg.

	A	B	C	D	E
50016-25	.235	1.85	2.31	.51	.32
50016-31	.313	2.32	2.95	.65	.41
50016-38	.350	2.54	3.22	.67	.43

CHAIN HARDWARE

Twin Clevis G70

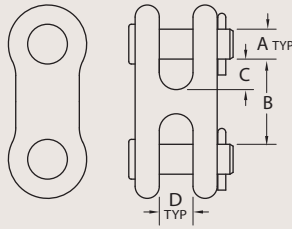

Forged steel with zinc plated gold chromate and individually polybagged

PART NUMBER	SIZE	WEIGHT	WLL	
50017-10	1/4-in. – 5/16-in.	.30 lbs./14 kg.	4,700 lbs./2,130 kg.	
50017-11	3/8-in.	.40 lbs./18 kg.	6,600 lbs./2,990 kg.	
50017-12	7/16-in – 1/2-in.	.98 lbs./44 kg.	11,300 lbs./5,130 kg.	
	A	B	C	D
50017-10	.38	1.18	.43	.47
50017-11	.47	1.34	.48	.53
50017-12	.56	1.75	.63	.65

Slip Hooks G70 without Safety Latch

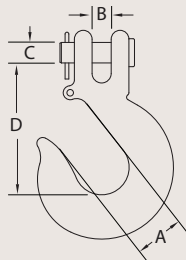

Forged steel with zinc plated gold chromate and individually polybagged

PART NUMBER	SIZE	WEIGHT	WLL	
50019-10	1/4-in.	.44 lbs./20 kg.	3,150 lbs./1,430 kg.	
50019-11	5/16-in.	.75 lbs./34 kg.	4,700 lbs./2,130 kg.	
50019-12	3/8-in.	1.13 lbs./51 kg.	6,600 lbs./2,990 kg.	
50019-13	1/2-in.	2.75 lbs./1.25 kg.	11,300 lbs./5,130 kg.	
	A	B	C	D
50019-10	.94	.44	.38	2.44
50019-11	1.06	.41	.44	2.72
50019-12	1.31	.59	.47	3.25
50019-13	1.75	.75	.63	4.00

Slip Hooks G70 with Safety Latch

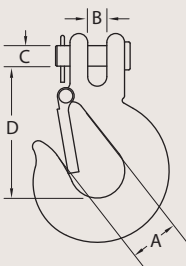

Forged steel with zinc plated gold chromate and individually polybagged

PART NUMBER	SIZE	WEIGHT	WLL	
50019-20	1/4-in.	.59 lbs./27 kg.	3,150 lbs./1,430 kg.	
50019-21	5/16-in.	.92 lbs./42 kg.	4,700 lbs./2,130 kg.	
50019-22	3/8-in.	1.32 lbs./60 kg.	6,600 lbs./2,990 kg.	
50019-23	1/2-in.	2.90 lbs./1.32 kg.	11,300 lbs./5,130 kg.	
	A	B	C	D
50019-20	.94	.44	.38	2.44
50019-21	1.06	.41	.44	2.72
50019-22	1.31	.59	.47	3.25
50019-23	1.75	.75	.63	4.00

FLATBED SOLUTIONS

EZ BINDER®



50140-10 EZ Load Binder
WLL: 5,400 lbs./2,450 kg. Weight: 11.5 lbs./5.22 kg.

- ▶ Ratchet design is easy to tension and release
- ▶ Extra long handle provides mechanical advantage
- ▶ Durable contoured handle grip for comfortable operation
- ▶ Heavy gauge steel construction with electro zinc plating
- ▶ Dual solid gears distribute tensioning forces evenly



50140-11 EZ Binder 6600
WLL: 6,600 lbs./3,000 kg. Weight: 13 lbs./59 kg.
Accepts chain from 5/16-in. G70 up to 3/8-in. G70

- ▶ Free wheel function for quick take up
- ▶ Quality grade 100 load chain is used in binder
- ▶ Use with 5/16-in grade 70 or 3/8-in grade 43 binder chains
- ▶ Swiveling grab hooks for ease of use
- ▶ Will take up 12-in of chain during tensioning



See how easy it is to use chain to secure heavy loads. Scan this QR Code for a demonstration video or go to our website at <https://www.ancracargo.com/ez-binder/c/208>

CHAIN LOAD BINDERS

All traditional chain load binders are constructed of drop forged steel for strength and durability and were designed to be used with NACM standard chain. They are available in traditional Lever, Recoilless and Ratcheting models, and are finished in a red E-coat paint. They meet or exceed WSTDA T-6 standards.

WARNING: Each Ankra chain binder is supplied with a tag containing warnings and instructions. Read all warnings and instructions before use. For chain securement systems, the rated WLL of the binder should be higher than or equal to the rated WLL of the chain size and grade being used. The WLL rating for a securement system is determined by the lowest WLL of any component of the system.

Lever Chain Load Binders



- 45943-12** 1/4-in. Lever Load Binder. Use with 1/4 inch G43 chain. WLL: 2,600 lbs./1,180 kg. Weight: 3.5 lbs./1.59 kg.
- 45943-10** 5/16-in. Lever Load Binder. Use with 5/16 G70 or 3/8 G43 chain. WLL: 5,400 lbs./2,450 kg. Weight: 7.9 lbs./3.59 kg.
- 45943-10HD** 5/16-in, Heavy-Duty Lever Load Binder. Use with 5/16 G70 or 3/8 G70 chain. WLL: 6,600 lbs./2,990 kg. Weight: 9.4 lbs./4.3 kg.
- 45943-11** 3/8-in Lever Load Binder. Use with 3/8 G70 or 1/2 G43 chain. WLL: 9,200 lbs./4,170 kg. Weight: 11.9 lbs./5.4 kg.
- 45943-13** 1/2-in Lever Load Binder. Use with 1/2 G70 or 5/8 G43 chain. WLL: 13,000 lbs./5,910 kg. Weight: 20.8 lbs./9.44 kg.

Recoilless Lever Chain Load Binders

- 45943-14** 5/16-in. Lever Load Binder. Use with 5/16 G70 or 3/8 G43 chain. WLL: 5,400 lbs./2,450 kg. Weight: 9.0 lbs./4.09 kg.



CHAIN LOAD BINDERS

Ratcheting Chain Load Binders



- 45943-20** 5/16-in Ratchet Load Binder. Use with 5/16 G70 or 3/8 G43 chain. WLL: 5,400 lbs./2,450 kg. Weight: 10.4 lbs./4.72 kg.
- 45943-20HD** 5/16-in, Heavy-Duty Ratchet Load Binder. Use with 5/16 G70 or 3/8 G70 chain. WLL: 6,600 lbs./2,990 kg. Weight: 10.5 lbs./4.8 kg.
- 45943-21** 3/8-in Ratchet Load Binder. Use with 3/8 G70 or 1/2 G43 chain. WLL: 9,200 lbs./4,170 kg. Weight: 11.8 lbs./5.36 kg.
- 45943-23** 1/2-in Ratchet Load Binder. Use with 1/2 G70 or 5/8 G43 chain. WLL: 13,000 lbs./5,910 kg. Weight: 15.7 lbs./7.13 kg.

XHD™ Chain Binders



- EXTRA SECURITY.** Constructed of drop forged steel and designed for durability and superior performance, XHD binders exceed WSTDA T-6 standards. The high visibility yellow E-coat finish protects against harsh elements and extreme road conditions. Available in 2 sizes: 5/16-in – 3/8-in x 6,600 lbs. and 3/8-in – 1/2-in x 9,200 lbs. 50360 binders are the original two-piece handle design that allows the main gear to be welded to the barrel making a more durable design than the standard binders in which the main gear is pinned to the barrel.
- ▶ Forged alloy steel
 - ▶ Stronger two-piece handle design with compression spring assembly
 - ▶ Welded gear assembly to barrel
 - ▶ Pre-lubricated Acme threaded screws
 - ▶ Internal thread stops to prevent over-extension and loss of capacity
 - ▶ 6-in take-up
- 50360-20** Chain size: 5/16-in. – 3/8-in. WLL: 6,600 lbs./3,000 kg. Weight: 12 lbs./5.4 kg.
 - 50360-21** Chain size: 3/8-in. – 1/2-in. WLL: 9,200 lbs./4,200 kg. Weight: 13 lbs./5.9 kg.

LEVER BINDER LOCKING CLIP



- 50117-10** Locking clip secures the handle on lever load binders to prevent the handle from opening and releasing chain tension. Yellow powder coated for corrosion protection and visibility. Weight: .40 lbs./0.18 kg.

FLOOR CHAIN TIE DOWNS

Floor chain tie down anchors are available in either weld-on or bolt-on models to meet your specific needs. Each with a working load limit of 6,000 lbs./2,724 kg. Each are made with 3/8-in grade 70 transport chain for strength and durability.

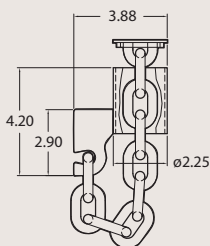

- 49345-10** Weld-on Black E-coat. Weight: 5.6 lbs./2.54 kg.

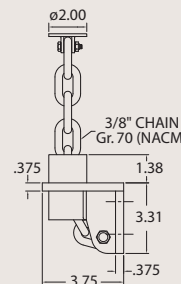

- 49583-10** Bolt-on Plated. Weight: 5.25 lbs./2.38 kg.

FLATBED SOLUTIONS

ANCRA X-TREME™ WEBBING PERFORMANCE LEADER

As the name implies, Ancra's X-TREME webbing offers our greatest performance, durability, strength and abrasion resistance. Because of its special weave construction and coating process, X-TREME realizes an impressive 80% minimum retained strength after abrasion testing, as opposed to 40% for standard webbing.

X-TREME's coating is durable and permanent, and reduces water absorption and freezing. Ancra X-TREME is available in popular winch and ratchet strap models that meet or exceed WSTDA T-1 standards. Custom lengths and end hardware quoted upon request.



ANCRA X-TREME™ WINCH STRAP ASSEMBLIES

Custom lengths and webbing configurations available.

2" WINCH STRAPS — WLL: 3,333 lbs./1,515 kg. using 41632-37 X-TREME Webbing



41659-90-27

2-in. x 27-ft. ANCRA X-TREME Strap w/ 40891-18 Flat Hook

41659-90-30

2-in x 30-ft. ANCRA X-TREME Strap w/ 40891-18 Flat Hook



41659-92-30

2-in x 30-ft. ANCRA X-TREME Strap w/ 43120-13 Wire Hook



41659-93-30

2-in x 30-ft. ANCRA X-TREME Strap w/ 43366-21 Chain Anchor



41659-94-30

2-in x 30-ft. ANCRA X-TREME Strap w/o hardware.
For winch to winch applications. Custom lengths available.



ANCRA X-TREME™ WINCH STRAP ASSEMBLIES

3" WINCH STRAPS — WLL: 5,400 lbs./2,450 kg. using 41632-38 X-TREME Webbing



41660-90-30

3-in. x 30-ft. ANCRA X-TREME Strap w/ 41766-18 Flat Hook



41660-93-30

3-in. x 30-ft. ANCRA X-TREME Strap w/ 43366-14 Chain Anchor



41660-95-30

3-in. x 30-ft. ANCRA X-TREME Strap w/o hardware. For winch to winch applications. Custom lengths available.

ANATOMY OF A WINCH STRAP

Overall Length

The overall distance from the tip of the attachment hardware (flat hook pictured) to the end of the webbing. Standard lengths are 27' and 30', with the most popular being 30'.



Hardware End

Webbing

Width

Determined by the width of the webbing used, 2", 3" or 4"



Label

Sewn near the hook end is our new extremely durable, yellow reinforced label with proper warnings, usage and working load limits in pounds and kilos.

FLATBED SOLUTIONS

ANCRA X-TREME™ WINCH STRAP ASSEMBLIES

4" WINCH STRAPS — WLL: 5,400 lbs./2,450 kg. using 43797-37 X-TREME Webbing



43795-90-27

4-in. x 27-ft. ANCRA X-TREME Strap w/ 41766-18 Flat Hook

43795-90-30

4-in. x 30-ft. ANCRA X-TREME Strap w/ 41766-18 Flat Hook

43795-90-40

4-in. x 40-ft. ANCRA X-TREME Strap w/ 41766-18 Flat Hook

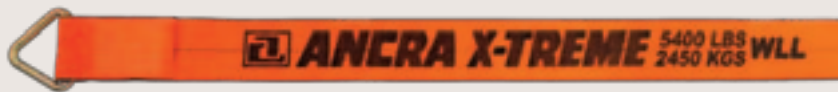

43795-91-27

4-in. x 27-ft. ANCRA X-TREME Strap w/ 41631-12 Delta Ring

43795-91-30

4-in. x 30-ft. ANCRA X-TREME Strap w/ 41631-12 Delta Ring

43795-91-40

4-in. x 40-ft. ANCRA X-TREME Strap w/ 41631-12 Delta Ring

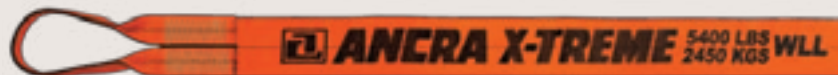

43795-93-30

4-in. x 30-ft. ANCRA X-TREME Strap w/ Half Twisted Loop



43795-95-30

4-in. x 30-ft. ANCRA X-TREME Strap w/ 43366-14 Chain Anchor



43795-92-30

4-in. x 30-ft. ANCRA X-TREME Strap w/o hardware. For winch to winch applications. Custom lengths available.

MILE AFTER MILE, YOUR DEPENDABLE CLASSIC.

Ancra Winch Strap Assemblies combine heavy-duty, wear and weather resistant latex treated polyester webbing with strong, dependable hardware to meet the demanding conditions of flatbed operations. Ancra straps meet FMCSA and CCMTA specifications and are tested for strength and durability. Meets or exceeds WSTDA T-1 Recommended Standard Specifications for synthetic web tie downs.



WINCH STRAP ASSEMBLIES

2" WINCH STRAPS — WLL: 3,333 lbs./1,515 kg. using 41632-46 Webbing



41659-10-27

2-in. x 27-ft. Winch Strap w/
40891-18 Flat Hook

41659-10-30

2-in. x 30-ft. Winch Strap w/
40891-18 Flat Hook



41659-11-27

2-in. x 27-ft. Winch Strap w/
40978-11 Delta Ring

41659-11-30

2-in. x 30-ft. Winch Strap w/
40978-11 Delta Ring



41659-13-27

2-in. x 27-ft. Winch Strap w/
43120-13 Wire Hook

41659-13-30

2-in. x 30-ft. Winch Strap w/
43120-13 Wire Hook



41659-15-27

2-in. x 27-ft. Winch Strap w/
43366-21 Chain Anchor

41659-15-30

2-in. x 30-ft. Winch Strap w/
43366-21 Chain Anchor



41659-16-30

2-in. x 30-ft. Winch Strap w/o hardware for winch to winch application.
Custom lengths available.

FLATBED SOLUTIONS

WINCH STRAP ASSEMBLIES

3" WINCH STRAPS — WLL: 5,400 lbs./2,450 kg. using 41632-14 Webbing



41660-10-27

3-in. x 27-ft. Winch Strap w/
41766-18 Flat Hook

41660-10-30

3-in. x 30-ft. Winch Strap w/
41766-18 Flat Hook



41660-14-27

3-in. x 27-ft. Winch Strap w/
43366-14 Chain Anchor

41660-14-30

3-in. x 30-ft. Winch Strap w/
43366-14 Chain Anchor



41660-18-27

3-in. x 27-ft. Winch Strap w/
43120-20 Wire Hook

41660-18-30

3-in. x 30-ft. Winch Strap w/
43120-20 Wire Hook



41660-17-30

3-in. x 30-ft. strap w/o hardware for winch to winch application.
Custom lengths available.

4" WINCH STRAPS — WLL: 5,400 lbs./2,450 kg. using 43797-12 Webbing



43795-10-27

4-in. x 27-ft. Winch Strap w/
41766-18 Flat Hook

43795-10-40

4-in. x 40-ft. Winch Strap w/
41766-18 Flat Hook



43795-11-27

4-in. x 27-ft. Winch Strap w/
41631-12 Delta Ring

43795-11-40

4-in. x 40-ft. Winch Strap w/
41631-12 Delta Ring

43795-10-30

4-in. x 30-ft. Winch Strap w/
41766-18 Flat Hook

43795-10-50

4-in. x 50-ft. Winch Strap w/
41766-18 Flat Hook

43795-11-30

4-in. x 30-ft. Winch Strap w/
41631-12 Delta Ring

43795-11-50

4-in. x 50-ft. Winch Strap w/
41631-12 Delta Ring

43795-10-35

4-in. x 35-ft. Winch Strap w/
41766-18 Flat Hook

43795-11-35

4-in. x 35-ft. Winch Strap w/
41631-12 Delta Ring



43795-13-30

4-in. x 30-ft. Winch Strap w/
Half Twisted Loop

43795-13-65

4-in. x 65-ft. Winch Strap w/
Half Twisted Loop



43795-14-27

4-in. x 27-ft. Winch Strap w/
43365-12 Grab Hook

43795-14-30

4-in. x 30-ft. Winch Strap w/
43365-12 Grab Hook

43795-13-45

4-in. x 45-ft. Winch Strap w/
Half Twisted Loop

43795-13-75

4-in. x 75-ft. Winch Strap w/
Half Twisted Loop

43795-13-50

4-in. x 50-ft. Winch Strap w/
Half Twisted Loop

WINCH STRAP ASSEMBLIES

4" WINCH STRAPS — WLL: 5,400 lbs./2,450 kg. using 43797-12 Webbing



43795-15-27

4-in. x 27-ft. Winch Strap w/
43366-14 Chain Anchor

43795-15-30

4-in. x 30-ft. Winch Strap w/
43366-14 Chain Anchor



43795-19-30

4-in. x 30-ft. Winch Strap w/o hardware for winch to winch
application. Custom lengths available.



43795-40-30

4-in. x 30-ft. Winch Strap w/ 41766-18 Flat Hook.
using 43797-19 Blue Webbing.



43795-60-30

4-in. x 30-ft. Winch Strap w/ 41766-18 Flat Hook.
using 43797-23 Crimson Red Webbing.

ROLL-ON/ROLL-OFF CONTAINER STRAPS

STANDARD



49526-10

4-in. x 5-ft. Strap w/ 48968-11 Container Hook.
WLL: 5,400 lbs./2,450 kg.



49526-11

4-in. x 5-ft. Strap w/ 48968-11 Container Hook and Sewn Loop
end. WLL: 5,400 lbs./2,450 kg.

ANCRA X-TREME™



49526-90

4-in. x 5-ft. Ancra X-TREME Strap w/ 48968-11 Container Hook.
WLL: 5,400 lbs./2,450 kg.



49526-91

4-in. x 5-ft. Ancra X-TREME Strap w/ 48968-11 Container Hook and
Sewn loop end.
WLL: 5,400 lbs./2,450 kg.

FLATBED SOLUTIONS

ENGINEERED FOR STRENGTH AND DURABILITY

Ancra Ratchet Buckle Strap Assemblies have redefined the industry standard. Now with the tested and proven 80% retained strength of Ancra X-TREME™ Webbing, as opposed to 40% for standard webbing, and the integrity of our ratchet buckles, these assemblies surpass the others. A complete line of Ancra's standard and heavy-duty assemblies and accessories can meet all your specific requirements.

- ▶ Custom lengths and a wide range of end hardware are available.
- ▶ Complies with WSTDA T-1 Standards
- ▶ Webbing meets or exceeds WSTDA T-4 Standards
- ▶ Standard fixed end length is 18-in., unless otherwise specified.



ANCRA X-TREME™ RATCHET STRAP ASSEMBLIES

2" ANCRA X-TREME RATCHET STRAPS USING 41632-37 WEBBING WITH LONG-WIDE HANDLE RATCHET BUCKLE 44587-10 — WLL: 3,333 lbs./1,515 kg.



45982-90-27

2-in. x 27-ft. ANCRA X-TREME Ratchet Strap w/ 40891-18 Flat Hooks.

45982-90-30

2-in. x 30-ft. ANCRA X-TREME Ratchet Strap w/ 40891-18 Flat Hooks.



45982-93-30

2-in. x 30-ft. ANCRA X-TREME Ratchet Strap w/ 43366-21 Chain Anchors. Fixed End 33-in.



45982-95-27

2-in. x 27-ft. ANCRA X-TREME Ratchet Strap w/ 43120-13 Wire Hooks.

45982-95-30

2-in. x 30-ft. ANCRA X-TREME Ratchet Strap w/ 43120-13 Wire Hooks.

3" ANCRA X-TREME RATCHET STRAPS USING 41632-38 WEBBING WITH RATCHET BUCKLE 48965-10 — WLL: 5,400 lbs./2,450 kg.



48987-90-27

3-in. x 27-ft. ANCRA X-TREME Ratchet Strap w/ 41766-18 Flat Hooks. Fixed End 22-in.

48987-90-30

3-in. x 30-ft. ANCRA X-TREME Ratchet Strap w/ 41766-18 Flat Hooks. Fixed End 22-in.



48987-92-27

3-in. x 27-ft. ANCRA X-TREME Ratchet Strap w/ 43366-14 Chain Anchors. Fixed End 37-in.

48987-92-30

3-in. x 30-ft. ANCRA X-TREME Ratchet Strap w/ 43366-14 Chain Anchors. Fixed End 37-in.

ANCRA X-TREME™ RATCHET STRAP ASSEMBLIES

4" ANCRA X-TREME RATCHET STRAPS USING 43797-37 WEBBING WITH RATCHET BUCKLE
49349-10 — WLL: 5,400 lbs./2,450 kg.



49346-90-27

4-in. x 27-ft. ANCRA X-TREME Ratchet Strap w/ 41766-18 Flat Hooks. Fixed End 20-in.

49346-90-30

4-in. x 30-ft. ANCRA X-TREME Ratchet Strap w/ 41766-18 Flat Hooks. Fixed End 20-in.



49346-91-27

4-in. x 27-ft. ANCRA X-TREME Ratchet Strap w/ 43366-14 Chain Anchors. Fixed End 35-in.

49346-91-30

4-in. x 30-ft. ANCRA X-TREME Ratchet Strap w/ 43366-14 Chain Anchors. Fixed End 35-in.



49346-93-27

4-in. x 27-ft. ANCRA X-TREME Ratchet Strap w/ 43120-20 Wire Hooks. Fixed End 20-in.

49346-93-30

4-in. x 30-ft. ANCRA X-TREME Ratchet Strap w/ 43120-20 Wire Hooks. Fixed End 20-in.

ANATOMY OF A RATCHET STRAP

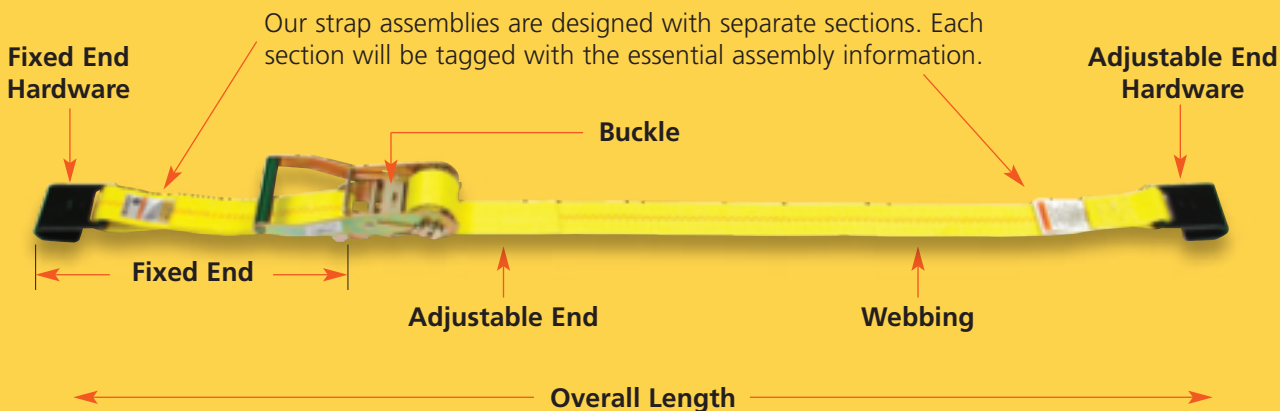

The distance between extreme end bearing points of the web tie down assembly, including the fittings. Standard fixed end length is 18" (33" for chain anchor straps). This puts the ratchet in the optimum position on the side of the trailer.

RATCHET STRAP ASSEMBLIES

The strength of Ancra Ratchet Strap Assemblies reflects the strength of Ancra's reputation in the Transportation Industry. Our heavy-duty, weather resistant straps and solid, reliable hardware have met the demands of the road for 50 years. Our straps are stringently tested for strength and durability in order to bear the Ancra name.

2" RATCHET BUCKLE STRAPS USING 41632-46 WEBBING WITH LONG-WIDE HANDLE RATCHET BUCKLE 44587-10 — WLL: 3,333 lbs./1,515 kg.



45982-10

2-in. x 27-ft. Ratchet Strap w/
40891-18 Flat Hooks.

45982-11

2-in. x 30-ft. Ratchet Strap w/
40891-18 Flat Hooks.



45982-15

2-in. x 27-ft. Ratchet Strap w/
43366-21 Chain Anchors.
Fixed End 33-in.

45982-34

2-in. x 30-ft. Ratchet Strap w/
43366-21 Chain Anchors.
Fixed End 33-in.



45982-19

2-in. x 27-ft. Ratchet Strap w/
40758-11 Twisted Snap Hooks.

45982-36

2-in. x 30-ft. Ratchet Strap w/
40758-11 Twisted Snap Hooks.



45982-42

2-in. x 27-ft. Ratchet Strap w/
43120-13 Wire Hooks.

45982-43

2-in. x 30-ft. Ratchet Strap w/
43120-13 Wire Hooks.

2" RATCHET BUCKLE STRAPS USING 41632-46 WEBBING WITH SHORT-WIDE HANDLE RATCHET BUCKLE 47105-11 — WLL: 3,333 lbs./1,515 kg.



47970-10

2-in. x 27-ft. Ratchet Strap w/
40891-18 Flat Hooks.

47970-11

2-in. x 30-ft. Ratchet Strap w/
40891-18 Flat Hooks.

2" RATCHET BUCKLE STRAPS USING 41632-46 WEBBING WITH STANDARD HANDLE RATCHET BUCKLE 44627-11 — WLL: 3,333 lbs./1,515 kg.



47971-10

2-in. x 27-ft. Ratchet Strap w/
40891-18 Flat Hooks.

47971-11

2-in. x 30-ft. Ratchet Strap w/
40891-18 Flat Hooks.

RATCHET STRAP ASSEMBLIES

3" RATCHET BUCKLE STRAPS USING 41632-14 WEBBING WITH RATCHET BUCKLE 48965-10 —

WLL: 5,400 lbs./2,450 kg.



48987-20

3-in. x 27-ft. Ratchet Strap w/ 41766-18 Flat Hooks.

48987-21

3-in. x 30-ft. Ratchet Strap w/ 41766-18 Flat Hooks.



48987-24

3-in. x 27-ft. Ratchet Strap w/ 43366-14 Chain Anchors. Fixed End 33-in.

48987-25

3-in. x 30-ft. Ratchet Strap w/ 43366-14 Chain Anchors. Fixed End 33-in.



48987-28

3-in. x 27-ft. Ratchet Strap w/ 43120-20 Wire Hook.

48987-29

3-in. x 30-ft. Ratchet Strap w/ 43120-20 Wire Hook.

4" RATCHET BUCKLE STRAPS USING 43797-12 WEBBING WITH RATCHET BUCKLE 49349-10 —

WLL: 5,400 lbs./2,450 kg.



49346-10

4-in. x 27-ft. Ratchet Strap w/ 41766-18 Flat Hooks.

49346-11

4-in. x 30-ft. Ratchet Strap w/ 41766-18 Flat Hooks.

WLL: 5,400 lbs./2,450 kg.



49346-14

4-in. x 27-ft. Ratchet Strap w/ 43366-14 Chain Anchors. Fixed End 33-in.

49346-15

4-in. x 30-ft. Ratchet Strap w/ 43366-14 Chain Anchors. Fixed End 33-in.

4" RATCHET BUCKLE STRAPS USING 41632-15 WEBBING WITH RATCHET BUCKLE 49349-10 —

WLL: 6,600 lbs./3,000 kg.



49346-12

4-in. x 27-ft. Ratchet Strap w/ 43120-20 Narrow Wire Hooks.

49346-13

4-in. x 30-ft. Ratchet Strap w/ 43120-20 Narrow Wire Hooks.

WEB KEEPER RATCHET STRAP ASSEMBLIES



Keep your excess webbing neat and secure with our new patented Web Keeper Ratchet Buckle Straps.

PATENTED

Tension your strap, roll up excess webbing and store it under the spring-loaded red bar. Straps are available in 30' lengths in flat hook and wire hook models in standard or 27' and 30' X-TREME™ Webbing. These straps have a fixed end length of 18" and meet or exceed WSTDA T-1 Standard Specification for synthetic web tie downs.

2" WEB KEEPER RATCHET BUCKLE STRAPS USING 41632-46 WEBBING WITH LONG-WIDE HANDLE WEB KEEPER RATCHET BUCKLE 50037-10 — WLL: 3,333 lbs./1,515 kg.



45982-11-30-WK

2-in. x 30-ft. Web Keeper Ratchet Strap w/ 40891-18 Flat Hooks.



45982-43-30-WK

2-in. x 30-ft. Web Keeper Ratchet Strap w/ 43120-13 Wire Hooks.

2" WEB KEEPER RATCHET BUCKLE STRAPS USING 41632-37 X-TREME WEBBING WITH LONG-WIDE HANDLE WEB KEEPER RATCHET BUCKLE 50037-10 — WLL: 3,333 lbs./1,515 kg.

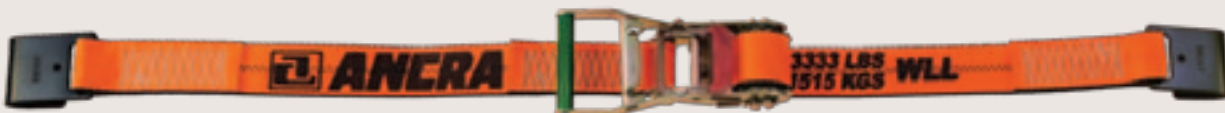

45982-90-27-WK

2-in. x 27-ft. X-TREME Web Keeper Ratchet Strap w/ 40891-18 w/ 40891-18 Flat Hooks.

45982-90-30-WK

2-in. x 30-ft. X-TREME Web Keeper Ratchet Strap w/ 40891-18 Flat Hooks.



45982-95-27-WK

2-in. x 27-ft. X-TREME Web Keeper Ratchet Strap w/ 43120-13 Wire Hooks.

45982-95-30-WK

2-in. x 30-ft. X-TREME Web Keeper Ratchet Strap w/ 43120-13 Wire Hooks.

RATCHET STRAP ASSEMBLIES



Flat Hook



Wire Hook



Chain Anchor



FOR ANCRA X-TREME™ 2" RATCHET STRAP ASSEMBLIES

Replacement for:

Replacement for:	Part No.	Description
45982-90-27 & -30	10632-90	2" x 18" Fixed end strap w/ 44587-10 Buckle and 40891-18 Flat hook
45982-90-27 & -30, 45982-90-27-WK, 45982-90-30-WK	10632-90-28	2" x 28' Adjustable end strap w/ 40891-18 Flat hook
45982-93-30	10632-93	2" x 33" Fixed end strap w/ 44587-10 Buckle and 43366-21 Chain Anchor
45982-93-30	10632-93-28	2" x 28' Adjustable end strap w/ 43366-21 Chain Anchor
45982-95-27 & -30	10632-95	2" x 18" Fixed end strap w/ 44587-10 Buckle and 43120-13 Wire hook
45982-95-27 & -30, 45982-95-27-WK, 45982-95-30-WK	10632-95-28	2" x 28' Adjustable end strap w/ 43120-13 Wire hook

FOR ANCRA X-TREME 3" RATCHET STRAP ASSEMBLIES

48987-90-27 & -30	10633-90	3" x 22" Fixed end strap w/ 48965-10 Buckle and 41766-18 Flat hook
48987-90-27 & -30	10633-90-28	3" x 28' Adjustable end strap w/ 41766-18 Flat hook
48987-92-27 & -30	10633-92	3" x 36" Fixed end strap w/ 48965-10 Buckle and 43366-14 Chain Anchor
48987-92-27 & -30	10633-92-28	3" x 28' Adjustable end strap w/ 43366-14 Chain Anchor

FOR ANCRA X-TREME 4" RATCHET STRAP ASSEMBLIES

49346-90-27 & -30	10634-90	4" x 18" +/- 2" Fixed end strap w/ 49349-10 Buckle and 41766-18 Flat hook
49346-90-27 & -30	10634-90-28	4" x 28' Adjustable end strap w/ 41766-18 Flat hook
49346-91-27 & -30	10634-91	4" x 33" +/- 2" Fixed end strap w/ 49349-10 Buckle and 43366-14 Chain Anchor
49346-91-27 & -30	10634-91-28	4" x 28' Adjustable end strap w/ 43366-14 Chain Anchor
49346-93-27 & -30	10634-93	4" x 18" +/- 2" Fixed end strap w/ 49349-10 Buckle and 43120-20 Wire hook
49346-93-27 & -30	10634-93-28	4" x 28' Adjustable end strap w/ 43120-20 Wire hook

FOR STANDARD 2" RATCHET STRAP ASSEMBLIES

Replacement for:

Replacement for:	Part No.	Description
45982-10 & -11, 47970-10 & -11, 47971-10 & -11, 45982-10-27-WK, 45982-11-30-WK	48922-10	2" x 18" Fixed end strap w/ 40891-18 Flat hook & loop end
45982-42 & -43	48922-13	2" x 18" Fixed end strap w/ 43120-13 Wire hook & loop end
45982-15 & -34, 45982-42-27-WK, 45982-43-30-WK	48922-16	2" x 33" Fixed end strap w/ 43366-21 Chain Anchor & loop end
45982-10 & -11	49347-10	2" x 18" Fixed end strap w/ 40891-18 Flat hook & 44587-10 Buckle
45982-42 & -43	49347-19	2" x 18" Fixed end strap w/ 43120-13 Wire hook & 44587-10 Buckle
45982-15 & -34	49347-28	2" x 33" Fixed end strap w/ 43366-21 Chain Anchor & 44587-10 Buckle
45982-10, 47970-10, 47971-10	49347-11	2" x 25' Adjustable end strap w/ 40891-18 Flat hook
45982-42	49347-20	2" x 25' Adjustable end strap w/ 43120-13 Wire hook
45982-15	49347-29	2" x 25' Adjustable end strap w/ 43366-21 Chain Anchor
45982-11, 47970-11, 47971-11	49347-12	2" x 28' Adjustable end strap w/ 40891-18 Flat hook
45982-43	49347-21	2" x 28' Adjustable end strap w/ 43120-13 Wire hook
45982-34	49347-30	2" x 28' Adjustable end strap w/ 43366-21 Chain Anchor

RATCHET STRAP ASSEMBLIES

FOR STANDARD 3" RATCHET STRAP ASSEMBLIES

Replacement for:

	Part No.	Description
48987-20 & -21	48922-11	3" x 18" Fixed end strap w/ 41766-18 Flat hook & loop end
48987-24 & -25	48922-17	3" x 33" Fixed end strap w/ 43366-14 Chain Anchor & loop end
48987-22 & -23	48922-20	3" x 18" Fixed end strap w/ 43365-12 Grab hook & loop end
48987-20 & -21	49347-13	3" x 18" Fixed end strap w/ 41766-18 Flat hook & 48965-10 Buckle
48987-24 & -25	49347-31	3" x 33" Fixed end strap w/ 43366-14 Chain Anchor & 48965-10 Buckle
48987-22 & -23	49347-40	3" x 18" Fixed end strap w/ 43365-12 Grab hook & 48965-10 Buckle
48987-20	49347-14	3" x 25' Adjustable end strap w/ 41766-18 Flat hook
48987-24	49347-32	3" x 25' Adjustable end strap w/ 43366-14 Chain Anchor
48987-22	49347-41	3" x 25' Adjustable end strap w/ 43365-12 Grab hook
48987-21	49347-15	3" x 28' Adjustable end strap w/ 41766-18 Flat hook
48987-25	49347-33	3" x 28' Adjustable end strap w/ 43366-14 Chain Anchor
48987-23	49347-42	3" x 28' Adjustable end strap w/ 43365-12 Grab hook

FOR STANDARD 4" RATCHET STRAP ASSEMBLIES

49346-10 & -11	48922-12	4" x 18" Fixed end strap w/ 41766-18 Flat hook & loop end
49346-12 & -13	48922-15	4" x 18" Fixed end strap w/ 43120-20 Wire hook & loop end
49346-14 & -15	48922-18	4" x 33" Fixed end strap w/ 43366-14 Chain Anchor & loop end
49346-10 & -11	49347-16	4" x 18" Fixed end strap w/ 41766-18 Flat hook & 49349-10 Buckle
49346-12 & -13	49347-25	4" x 18" Fixed end strap w/ 43120-20 Wire hook & 49349-10 Buckle
49346-14 & -15	49347-34	4" x 33" Fixed end strap w/ 43366-14 Chain Anchor & 49349-10 Buckle
49346-10	49347-17	4" x 25' Adjustable end strap w/ 41766-18 Flat hook
49346-12	49347-26	4" x 25' Adjustable end strap w/ 43120-20 Wire hook
49346-14	49347-35	4" x 25' Adjustable end strap w/ 43366-14 Chain Anchor
49346-11	49347-18	4" x 28' Adjustable end strap w/ 41766-18 Flat hook
49346-13	49347-27	4" x 28' Adjustable end strap w/ 43120-20 Wire hook
49346-15	49347-36	4" x 28' Adjustable end strap w/ 43366-14 Chain Anchor



TIE DOWN TIPS

From the Web Sling and Tie Down Association

- ▶ The angle from the horizontal (tie down to trailer deck) has an enormous influence on load securement.
- ▶ If the angle is 90 degrees, the effective downward pressure is 100% of the tie down tension.
- ▶ If the angle is 60 degrees, the effective downward pressure is reduced to 87% of the tie down tension.
- ▶ If the angle is 45 degrees, the effective downward pressure is reduced to 71% of the tie down tension.
- ▶ If the angle is 30 degrees, the effective downward pressure is reduced to 50% of the tie down tension.
- ▶ For more information about the Recommended Standard for Tie Downs, contact WSTDA. www.wstda.com



To help prevent unrated straps, Ancra uses high-quality, tear and fade-resistant, reinforced vinyl WLL labels on all flatbed tie downs.

FLATBED ACCESSORIES

Cable Assemblies with Chain Anchor



Ankra's heavy-duty cable assemblies with zinc-plated gold chromate chain anchor can be used on cable, combination winches, or web winches with side washers to prevent binding. Constructed of galvanized aircraft cable with grade 70 NACM-compliant chain anchor. The cable assemblies are available in 7/32", 1/4" and 5/16" diameter cable in 30' and 32' lengths. The chain anchors are 19" in length.

49828-12-30

7/32" x 30' Weight: 4.9 lbs./2.2 kg. WLL: 1,867 lbs./848 kg.

49828-12-32

7/32" x 32' Weight: 5.1 lbs./2.3 kg. WLL: 1,867 lbs./848 kg.

49828-10-30

1/4" x 30' Weight: 5.4 lbs./2.45 kg. WLL: 2,300 lbs./1,050 kg.

49828-10-32

1/4" x 32' Weight: 5.8 lbs./2.6 kg. WLL: 2,300 lbs./1,050 kg.

49828-11-30

5/16" x 30' Weight: 7.9 lbs./3.6 kg. WLL: 3,300 lbs./1,500 kg.

49828-11-32

5/16" x 32' Weight: 8.4 lbs./3.8 kg. WLL: 3,300 lbs./1,500 kg.

ANCRAX-TREME™ ROPE TIE DOWN

Lightweight solution for heavyweight loads. When hauling heavy duty loads like timber, Ankra X-TREME Rope Tie Downs provide you with a lightweight alternative to steel cable tie downs. Made of ultra high molecular weight polyethylene for high strength and low stretch, the user-friendly rope with 3/8" diameter and breaking strength of 18,000 pounds will not develop kinks or broken wires.

Rope Tie Downs also feature:

- ▶ Spliced eye loop on the end for connection to three-bar winch
- ▶ 21"-long chain anchor on opposite end is made with 5/16" Grade 70 chain and grab hook
- ▶ Complies with FMCSA and has rated WLL of 3600 lbs./1,635 kg
- ▶ Metal tag attached is marked, "Ankra, 50404-10, WLL 3600 lbs, 1365 kg"



Ankra X-TREME Rope Tie Down

50404-10-33 Length: 33 ft.

50404-10-36 Length: 36 ft.

50404-10-40 Length: 40 ft.

T'OSS 'N TIE™

You don't have to throw your tie downs over the load and equipment and risk harm to yourself, others, or your load! Toss 'N Tie is an easy way to get tie downs in place efficiently and safely.



Three easy steps:

1. Unroll cord and attach a cargo strap or cargo chain.
2. Toss the Toss 'N Tie ball up and over load.
3. Go to the other side, grab cord and pull your tie down into place.

50409-10-1PK

Toss 'N Tie™

Single Pack. Weight: .72 lbs.



FLATBED ACCESSORIES

5th Wheel Release Hook

50354-10 With a 5-inch tee-handled grip, the hook end releases the locking pin on a 5th wheel connection. The short angled bar releases the secondary lock found on some models.

- ▶ Chrome plated finish
- ▶ Welded steel construction
- ▶ Total product length: 34.5 inches
- ▶ Weight: 1.89 lbs./.86 kg.



Works with IOS and Android mobile devices



Ankra Helps Keep You In Compliance with the Law

Ankra's mobile tie-down-calculator app is available at no cost.

Better safe than sorry. Ankra's free mobile app helps you determine the minimum strap requirements to comply with FMCSA and CCMTA.

Our app lets you work in standard or metric measurements and gives you the option to enter custom article lengths and weights. It will also store Working Load Limits of straps for future use and links to the FMCSA website for more information.

Available on the App Store and on Google Play.

It's free.

INTERIOR VAN SOLUTIONS

From decking systems, track, beams and bars, to strap assemblies and custom nets, Ancra's Interior Van Solutions are made of quality components to secure your loads. Whether your application is standard or heavy-duty, your solution is here.

- Loading systems match your application
- Track treated with high quality finishes for corrosion resistance
- Versatile beams and bars with the best possible strength-to-weight ratio
- Replacement parts for added life and efficiency
- Strength tested and highway proven



INTERIOR VAN SOLUTIONS

AUTODECK® AUTOMATED TRAILER DECKING SYSTEM

NEW Ancra engineering has advanced cargo decking from integrated manual systems to the next level with the automated innovation of AutoDeck. With all the space utilization and increased load averages of Ancra's manual systems, AutoDeck builds on those advantages with speed and simplicity, reducing damage freight claims, time to load, and maintenance costs while improving driver and forklift operator safety and workload ease.

Push-button benefits

Recognized by *Heavy Duty Trucking* as one of its Top 20 Products, this wireless system allows you to load a trailer 20% faster at the push of a button. AutoDeck is designed with a reinforced double flanged track that recesses the drive belt behind the trailer wall, shielding components to prevent damage from forklift or freight. Its beam assembly provides smooth beam movement and greater loading speed and efficiency.

With its drivetrain components life-cycle tested and demonstrated to operate in excess of 20 years, AutoDeck:

- ▶ Maintains 50% more reduction in damage claims
- ▶ Increases loading/unloading efficiency 20% faster than integrated decking systems
- ▶ Improves material handler safety
- ▶ Increases cargo cubic capacity
- ▶ Increases equipment utilization over integrated systems ROI in as little as 18 months
- ▶ Features modular sub-assemblies for simplified maintenance

PATENT PENDING

AutoDeck®

LOADED WITH POWER



Green lights indicate the system is stored and locked in place at the ceiling. Lights flash red when beams move up or down.



Wireless feature enables the use of autonomous vehicles for a completely automated cross-dock or warehouse.



Learn more about the versatile, fast and safe AutoDeck system and watch a demonstration of its smooth and simple operation. Scan this QR Code for a how-to video at: <https://www.ancracargo.com/autodeck/c/94>

VERS-A-DECK®

Maximize your decking. Vers-A-Deck lets you customize deck heights to handle various size and weight loads. By using E Beams and Vers-A-Deck beams on the same track system, you can create double decking. Use either 16- or 24-inch track spacing. 16-inch spacing has 3000 pound weight limit rating. 24-inch spacing has 2250 weight limit rating.

Vers-A-Deck's key benefits:

- ▶ Accommodates Vers-A-Beams and E Beams in the same system at the same deck height
- ▶ Customized deck heights allow increased load average while avoiding damage from double stacking
- ▶ Easy maintenance and repair and stores in ceiling
- ▶ 2-year warranty
- ▶ Stores in the ceiling
- ▶ Works ideally with Ancra Poly Deckboard and accommodates standard logistics straps for securing cargo in place.

PATENT PENDING



Cargo Weight Limit Per Decking Position

BEAM TYPE	16" SPACING	24" SPACING
Low Profile	3000 lbs 1360 kgs	2250 lbs 1020 kgs

Vers-A-Deck®

— NEXT GENERATION DECKING SYSTEM —

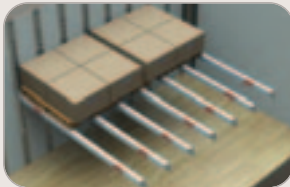

50459-10

Warning, Instruction and Maintenance placard

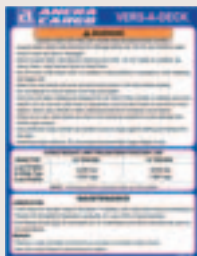

50418 Series

Standard Single Flush Mount Track. Bonded Installation Recessed in Wall Panel



50419 Series

Low Profile Single Surface Mount Track. Also available for bonded installation.



50414-30

Vers-A-Deck Beam End Assembly for Low Profile Beams. Slot allows for 7 5/8" of extension per beam end.



50414-31

Replacement VAD Foot Assembly Replacement beam foot assembly.



PATENT PENDING

50486-10 Rubber Beam Stop

Easy to Install. Weight: .05 lb./02 kg.



50587-10

Wide Top Low Profile Beam Assembly WLL: 3,000 lbs./1360 kg. Max Cargo: 750 lbs. / 340kg. Length: 98"-113.4"/ 249 to 288 cm.

INTERIOR VAN SOLUTIONS

LIFT-A-DECK® II

The most popular solution for decking loads in trailer and van bodies.

With Ancra's adjustable second deck in your trailer, you can carry double the amount of palletized freight, or you can mix loads with only part of the vehicle double decked. Either way, you can increase your payload capacity and your profits. For the loads where you need full height, you simply push the adjustable beams to the roof for convenient and safe storage. There will be no more beams left on the loading dock. With many track styles to choose from, installations can be made on any type of vehicle construction, including sheet and post. Lift-A-Deck II track can also be used with a wide range of Ancra accessories for cargo containment. *For information about Ancra's two-year warranty, call our Customer Service Department at 800-233-5138.*

Convenient storage.

When not in use, beams are easily pushed to the roof for secure storage. No more lost beams.

Easy operation.

Beams are easily moved by one operator.

Super strength.

Ancra Wide Top Beams have the highest rating in the industry. Working Load Limit – 4,000 lbs./1,816 kg.

Wide range of accessories.

Lift-A-Deck II track can be used for securing loads with cargo straps, tie-offs, and decking/shoring beams.



Fits all trailers.

Available for 96 or 102 inch trailer widths and height can be specified. Track also can be made as an integral part of sidewall structure.

Versatile.

Beams can be adjusted in one-inch increments to accommodate various loads within a trailer. Only Ancra offers this much adjustability.

Snag resistant.

Low profile track design with sloping shoulders helps protect against forklift damage and allows for surface mounting. Standard track length is 72-inches. Custom lengths are available.

Simple, yet secure.

Double engagement lock on the aluminum beam features a simplified trigger release mechanism. Internal locking design helps protect against forklift damage.

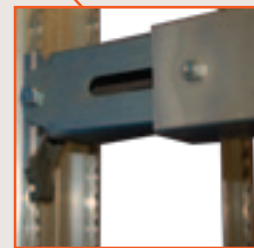

LIFT-A-DECK® II

Only Ankra gives you so many decking options.

Cargo beams and Lift-A-Deck beams are rated at Working Load Limits (WLL) that are 1/3 of the breaking strength or failure load capacity of the beams. In order to account for dynamics and vibrations that are experienced during transit and avoid overloading the beams beyond the WLL rating, the actual weight of cargo supported by the beams should be reduced below the rated WLL value of the beam. The allowable weight of cargo supported by the beams should be factored down based on anticipated dynamic G forces expected during transit. Below are typical examples of de-rated weight carrying values for decking systems based on typical 4G transport dynamics.

Recommended Maximum Cargo Weight per 4' Decking Position - lbs	BEAM TYPE	24" Track Spacing		16" Track Spacing	
		S-S-S (single-single-single)	D-S-D (double-single-double)	S-S-S-S (single-single-single-single)	D-S-S-D (double-single-single-double)
	Standard	1100	1650	1650	2200
	Heavy Duty	1500	2250	2250	3000
	Reinforced Wide	2000	3000	3000	4000

Note: A decking position is typically made up of two pallets.

- ▶ Beams can be positioned in one-inch increments for most efficient utilization of space
- ▶ Beams easily moved by just one operator
- ▶ Low Profile locking mechanism to help protect against forklift damage.



See how Lift-A-Deck maximizes your cargo area to increase profits. Scan this QR Code for a how-to video or go to our website at <https://www.ancracargo.com/lift-a-deck/c/807>

STANDARD AND LOW PROFILE BEAMS W/ LOW PROFILE FOOT AND CHANNEL ASSEMBLY



PATENTED

49414-15

Standard LAD Beam
Adjustment range: 95.1" – 105.6"
Weight: 18.1 lbs./8.2 kg.
Decking WLL: 2,200 lbs./999 kg.*
Shoring WLL: 2,200 lbs./999 kg.



PATENTED

49414-19

Heavy Duty LAD Beam
Adjustment range: 95.1" – 105.6"
Weight: 19.7 lbs./8.9 kg.
Decking WLL: 3,000 lbs./1,360 kg.*
Shoring WLL: 2,500 lbs./1,135 kg.

WIDE TOP BEAM W/ LOW PROFILE FOOT AND CHANNEL ASSEMBLY

The textured Beam top surface is 4-1/2" wide to increase the contact area for cargo on the beam deck.



PATENTED

PATENT PENDING

50080-11

Wide Top LAD Beam Assembly
Adjustment range 95.1" – 105.6"
Weight: 24.9 lbs./11.3 kg.
Decking WLL: 4,000 lbs./1,816 kg.*
Not recommended for shoring.



PATENTED

50312-10

Wide Top LAD Beam
w/ Reinforced 1-in. Sides
Adjustment range: 95.1" – 105.6"
Weight: 26.7 lbs./12.1 kg.
Decking WLL: 4,000 lbs./1,814 kg.*
Shoring WLL: 2,500 lbs./1,135 kg.

50312-10-RT Replacement tube for 50312-10. Length 90.71 inches.

*** WARNING:** Never exceed trailer manufacturer decking load limits. Do not create an unstable, top heavy trailer. Load heavier items on trailer floor.

INTERIOR VAN SOLUTIONS

LIFT-A-DECK® II

BEAM ACCESSORIES AND COMPONENTS — RT Beams have all the required labels.



49414-15-RT

Replacement Tube for 49414-15 Standard LAD Beam. Length 90.71 inches. Weight: 11.2 lbs./5.1 kg.

49414-19-RT

Replacement Tube for 49414-19 Heavy-Duty LAD Beam. Length 90.71 inches. Weight: 14.3 lbs./6.5 kg.

50080-11-RT

Replacement Tube for 50080-11 Wide Top LAD Beam. Length 90.71 inches. Weight: 19.5 lbs./8.8 kg.



49445-12 Beam Release Bar
Length: 52 inches.
Weight: 2.5 lbs./1.14 kg.

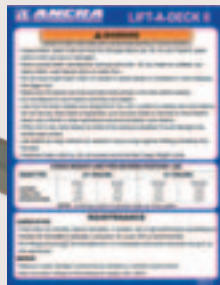

49446-10

Lift-A-Deck Kit

Lift-A-Deck Kit includes the

49445-12 Beam Release Bar and 49438-14 Warning, Operations and Maintenance placard. Weight: 2.5 lbs./1.14 kg.

PRODUCT FEATURES

WITH MORE THAN 100,000 SYSTEMS OPERATING YEAR AFTER YEAR WITH LOW MAINTENANCE COSTS, LIFT-A-DECK IS THE DECK SYSTEM MOST REQUESTED BY MAJOR FLEETS.

- + NO TRACK LUBRICATION REQUIRED.
- + SYSTEM TRACK AND FOOT-ASSEMBLIES ARE PRECISION MACHINED RESULTING IN SMOOTH SLIDING BEAMS.
- + EVALUATION, TESTING, TRAINING AND INSTALLATION BY CERTIFIED DECK SPECIALISTS WILL HELP DETERMINE THE BEST LAD II SYSTEM FOR YOUR APPLICATION AND ENSURE MAXIMUM EFFICIENCY AND ROI.

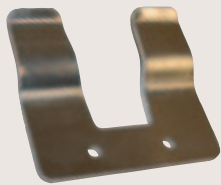

50055-10

Beam Release Bar Holder
Weight: .44 lb./0.2 kg.



NEW 49384-12

Steel Beam Track Stop
Weight: 0.4 lb./0.2 kg.



50486-10

Rubber Beam Stop
Easy to Install.
Weight: .05 lb./0.02 kg.



50187-30

Lift-A-Deck II Low Profile Foot and Tube Assembly.

Machined guide shoe allows for inspection of the locking elements while foot is installed in track. Features a coil spring for optimum service life. Weight: 3.1 lbs./1.41 kg.



50524-10

Lift-A-Deck II High rise foot beam end assembly for LAD (at bottom with other feet).
Weight: 3.5 lbs./1.59 kg.



50187-31

Lift-A-Deck II Low Profile Foot Assembly. Machined guide shoe allows for inspection of both locking lugs while beam remains installed in the track. Features a coil spring for optimum service life. Weight: 0.6 lbs./0.27 kg.

AFTERMARKET DECKING SYSTEM BEAMS

AFTERMARKET DECKING BEAMS — OLDER STYLE CAPTIVE BEAM SYSTEMS



49414-21

Standard Aftermarket Beam
Adjustment range 97.3" – 108.8"
Weight: 23.7 lbs./10.76 kg.
Decking WLL: 2,200 lbs./1,000 kg.
Shoring WLL: 1,500 lbs./680 kg.



50191-10

Heavy-Duty Aftermarket Beam
Adjustment range 97.3" – 108.8"
Weight: 25.3 lbs./11.49 kg.
Decking WLL: 2,200 lbs./1,000 kg.
Shoring WLL: 1,500 lbs./680 kg.



PATENTED



50186-10

Wide Top Aftermarket Beam
Adjustment range 97.3" – 108.8"
Weight: 30.5 lbs./13.85 kg.
Decking WLL: 2,500 lbs./1,135 kg.
Not recommended for shoring.

** Note: Also consult trailer or truck body manufacturer for their recommended load capacity of secondary deck.*

AFTERMARKET BEAM ACCESSORIES AND COMPONENTS — RT Beams have all the required labels.



49414-21-RT (shown above)
Replacement Tube for 49414-21 Standard Aftermarket Beam. Length 90.71 inches.
Weight: 11.2 lbs./5.1 kg.

50191-10-RT
Replacement Tube for 50191-10 Heavy-Duty Aftermarket Beam. Length 90.71 inches.
Weight: 14.3 lbs./6.5 kg.

50186-10-RT
Replacement Tube for 50186-10 Wide Top Aftermarket Beam. Length 90.71 inches.
Weight: 19.5 lbs./8.8 kg.

50188-10
Foot and Channel Assembly for 49414-22, 50186-10 and 50191-10 Aftermarket Beams.
Weight: 5.9 lbs./2.68 kg.



50194-100

Low Profile Allen Sleeve Nut and Bolt Kit
Kit consists of (1) 50194-10 Bolt and (1) 50194-11 Sleeve Nut. Low profile allen head bolt and sleeve nut with a semi-flush head height of .10". Used for attaching channel assemblies to beams. The bolt has a self locking patch to prevent loosening due to vibration. For 43638, 49039, 49360, 49414, 50080, 50158, 50186, 50191 and 50420 beams. Weight: .10 lb./5 kg.



LIFT-A-DECK® II

Lift-A-Deck® II Track Options

- ▶ Widest choice of track types to meet every application.
- ▶ No track lubrication is required.
- ▶ Beam access slot is provided as standard for all track for easy beam removal and replacement. Standard track length is 72 inches (61 inch loadable). Custom lengths and an installation manual are available upon request.

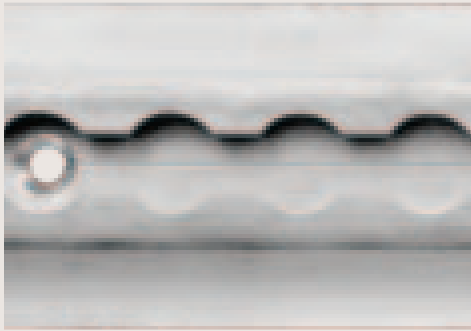

50192-14-72.00
Standard Single Track

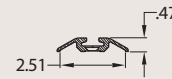
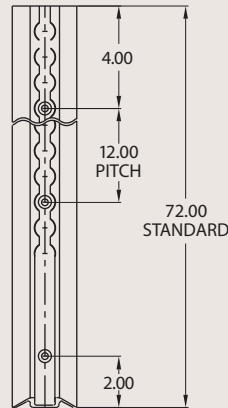

50058-18-72.00
Flanged Single Track. Beveled, Weight: 4.2 lbs./ 1.9 kg.

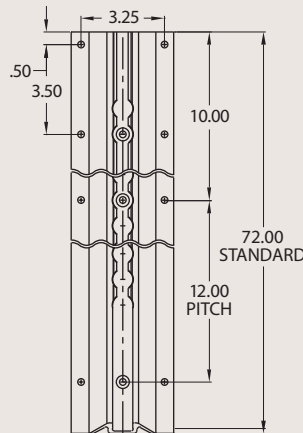

49562-17-72.00
Narrow Single Track

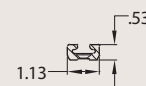
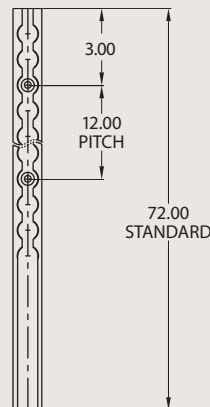

LIFT-A-DECK® II

LIFT-A-DECK® II TRACK OPTIONS

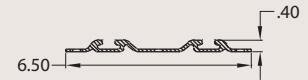
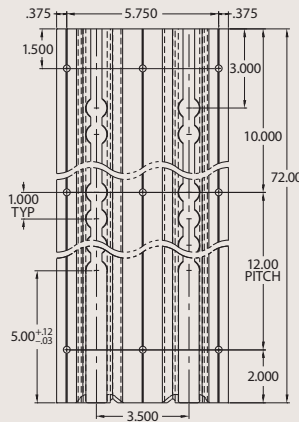
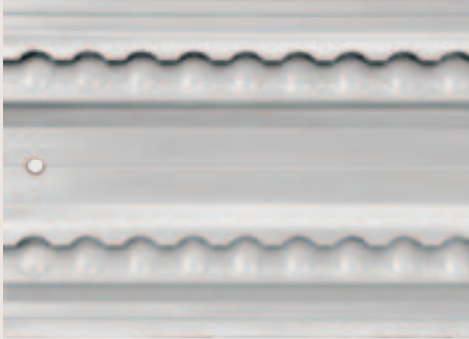

50072-14-72.00

Flanged Double Track
Beveled, Weight: 6.8 lbs./3.1 kg.

LIFT-A-DECK® II LOGISTIC STRAPS



6,000 lb. Polyester Webbing (47200) with Cam Buckle (40880-15) and (50112-10) Single Stud Fitting. Fixed End: 48-in. Working Load Limit: 833 lbs./378 kg.

Part No.	Length	Weight
40602-100	12 ft.	1.40 lbs.
40602-101	16 ft.	1.55 lbs.
40602-102	20 ft.	1.70 lbs.



6,000 lb. Polyester Webbing (47200) with Ratchet Buckle (44258-13) and (50362-11) Double Stud Fitting. Fixed End: 48-in. Working Load Limit: 1,500 lbs./680 kg.

Part No.	Length	Weight
48672-16	12 ft.	2.50 lbs.
48672-17	16 ft.	2.65 lbs.
48672-18	20 ft.	2.80 lbs.

FASTRACK™ LIFT-A-DECK II CONVERSION TRACK

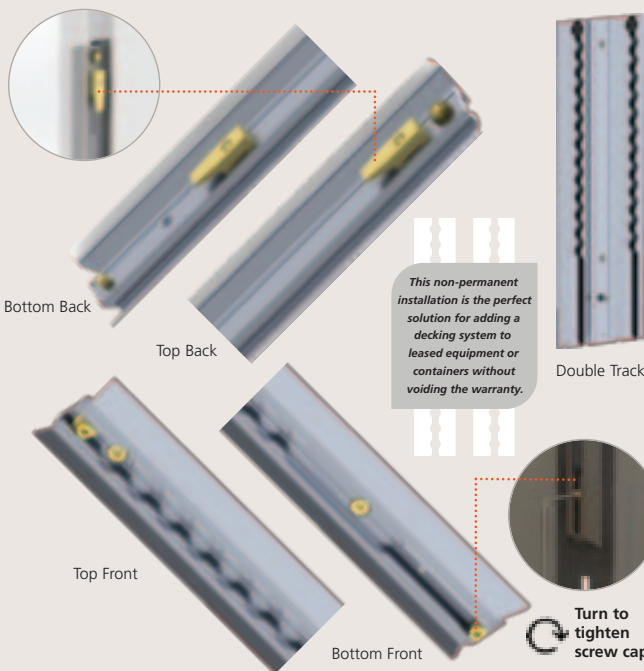

NEW FASTRACK™ PATENTED

50530 Series FasTrack™ Lift-A-Deck II Conversion Track

The FasTrack™ Lift-A-Deck II Conversion system is available in single or double track with brackets attached to the back for mounting into vertical logistics post slots. With the addition of a Lift-A-Deck II beam, this track easily converts a standard dry van trailer into a captive beam Lift-A-Deck II decking trailer without requiring a permanent installation. FasTrack™ provides all the benefits of traditional captive decking systems along with the versatility of short-term usage or customer demonstration.

- ▶ 50530-10 is a 78" long beveled single track assembly.
- ▶ 50530-20 is a 78" long beveled double track assembly.
- ▶ Brackets are spaced every 12" to mount to standard vertical E/A slots on 4" or 6" centers.
- ▶ A beam stop is included at top of the LAD II conversion track. A beam stop should be installed above the insertion slot after a beam has been inserted into the track to captivate the beam.
- ▶ A ¼-20 socket head cap screw, provided with the conversion track, keeps track secured into logistics post.
- ▶ This non-permanent installation is the perfect solution for adding a decking system to leased equipment or containers without voiding the warranty.

50530-10
FasTrack™ Single Track

50530-20
FasTrack™ Double Track

INTERIOR VAN SOLUTIONS

LOGIST'A-PANEL™

New levels of Lift-A-Deck and Vers-A-Deck. Logist-A-Panel combines Ankra's proven Lift-A-Deck II beam system with slotted wall panels replacing the standard plywood or liner panel inside your trailer to create highly customizable shoring and strapping options for loads of all sizes. Versatile and efficient with the strength and durability Lift-A-Deck II is known for, Logist-A-Panel wall system adds capacity to customize to your specific load.

A retrofit kit contains preassembled logistics panels with Lift-A-Deck II track in a variety of options including flush and surface mount, beams and accessories kit for quick and easy installation. Quickly convert a 24-inch post spaced trailer to 16-inch post spacing.



Logist-A-Panel.
Surface Mount Track.



PATENTED

Logist-A-Panel.
Standard Single.
Flush Mount Track.
Recessed in Wall Panel.



Logist-A-Panel w/
Beam Release Bar Holder.

POLY DECKBOARD

PATENTED



Poly Deckboard for Lift-A-Deck or Vers-A-Deck System and E Beams

- ▶ Lighter than plywood - Increase trailer capacity
- ▶ Ergonomic - Convenient hand slot
- ▶ Splinter Proof - Reduces labor to clean out trailers and docks - longer life than plywood
- ▶ Stackable - Nests for storage
- ▶ Durable - Reduces purchase frequency
- ▶ Recyclable - Energy savings
- ▶ Tough high density polyethylene has excellent low temperature performance down to -40°F
- ▶ Tested to demonstrate durability under load and vibration at -40°F



50105-11

Poly Deckboard
For beams set at 16" and 24" spacing.
48" x 48" x 2.7"H
Weight: 21 lbs./9.53 kg.



Scan this QR Code to go to our website at
<https://www.ancracargo.com/poly-deck-board/c/284>

SECURITY DIVIDER & DECKBOARD

PATENTED

Versatile Security Divider & Deckboard.

High density polyethylene panels with hand slots for easy positioning are ideal for moving household items, keeping your freight separate and secure. Used with lockable beams to provide a secure load divider for missed loads. When used as a decking board, the cargo carrying capacity is determined by the beam supporting it.

- ▶ Kit includes 2 lockable E Beams and 2 Panels
- ▶ For use with Standard and Heavy Duty E Beams
- ▶ Splinter proof
- ▶ 3-year Warranty

Special Order Item! Call customer service for more details, 800-233-5138.



Panel can also be used as a 4' x 8' decking board.

50514-10

Single Panel

96" h x 48" w x 4" d
Weight: 44 lbs./20 kg.

50515-11

Bulkhead Kit, 2 Panels & 2 STD Lockable Beams

Standard Duty Beams
QTY: 2 (43638-59)
96" h x 96" w x 4" d
Total Kit Weight:
126 lbs./57 kg.

50515-10

Bulkhead Kit, 2 Panels & 2 HD Lockable Beams

Heavy Duty Beams QTY: 2 (49039-59)
96" h x 96" w x 4" d
Total Kit Weight: 133 lbs./60 kg.



Lockable E-Beam

CART SECUREMENT SYSTEM

Narrow profile shoring beams utilized.

- ▶ Beam space optimization ensures maximum number of carts loaded
- ▶ Safer and more secure – carts cannot accidentally release and roll out of rear door when opened
- ▶ Replaces use of straps
- ▶ Beams stay with trailer
- ▶ Damaged beams are easy to replace
- ▶ Narrow shoring beams are used only for shoring, never decking

Use Ankra's Beam Release Tool to easily move beams (P/N: 49445-12)

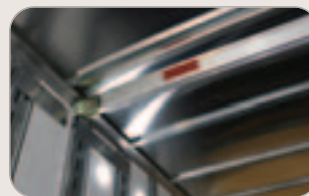

INTERIOR VAN SOLUTIONS

KNOCK DOWN PALLET DECK



Collapsible, stackable, durable.

For greater efficiency and safety, the Knock Down Pallet Deck (KDPD) features legs that automatically deploy. When extended, the folding legs interlock with the fixed nesting legs for additional stability and better distribution of weight. A self-contained system, the KDPD needs no extra parts to be lost or damaged. When folded, the pallet nests securely with other KDPD units for an efficient, space-saving solution, 92-inch wide x 47-inch deep x 56-inch high.

PATENTED

50480-100 Knock Down Pallet Deck

Full Dimensions: 92 in x 47 in x 56 in. Folded Dimensions:

92 in x 47 in x 14.1 in. WLL: 5,000 lbs./ 2,268 kg.

Special Order Item! Call customer service for more details, 800-233-5138.



PALLET DECK



49988-10 Pallet Deck

Add another deck to double your freight and your profits, and reduce damage claims. Pallet Deck is made from 2-inch square tube with zinc flo-coat finish 46-inch deep x 92-inch wide x 56-inch high. WLL: 5,000 lbs./ 2,268 kg.



INTERIOR VAN SOLUTIONS

RETRACT-A-ROLL PUTS HIGH-SPEED AIRCRAFT-CARGO LOADING IN YOUR TRAILER.



Move 1,000 pound loads with one finger.

Ankra's next-generation retractable roller system lifts cargo so workers can glide it into position for faster loading and unloading.

Proven in airports worldwide, the system moves thousands of tons of air cargo every day. Fast loading and unloading reduces handling time, lowers labor costs and speeds turn-arounds. Retract-A-Roll is extremely versatile—it handles air freight, palletized freight and instantly converts to a flat floor for handling general freight.

Operated by pneumatics from the truck's existing air supply, it is extremely rugged.



Air bag assembly protection.
Ankra's exclusive air bag sleeve offers 360° protection plus the industry's best air bag warranty.

Steel top plate and rollers fend off forklifts while lower sections are aluminum to reduce weight. All parts are easily accessed for inspection or repair. Centralized weather-proofed controls are simple: one valve raises or lowers rollers.

Now offering composite batten kits.

RETRACT-A-ROLL SPECIFICATIONS

Conveyor width:	4.2 inches (107 mm)
Conveyor height:	2.75 inches (70 mm)
Conveyor weight:	7.2 lbs/ft (10.7 kg/m)
Inflated height:	3.3 inches (84 mm)
Axle spacing:	4", 6" or combination pitch
Conveyor lengths:	8', 10' and 13' (standard) 2.4 m, 3 m, 4 m (standard)
Lifting capacity:	450 lb/ft (671 kg/m)
Operating air pressure:	30 psi / 2 bar
Control box:	Weatherproof with centralized controls



60169-10 Auxiliary Air Tank Kit



Dual Skate Wheels

Retract-A-Roll 2



2-inch rollers have 250 lb/ft (671 kg/m) bearing capacity per roller.

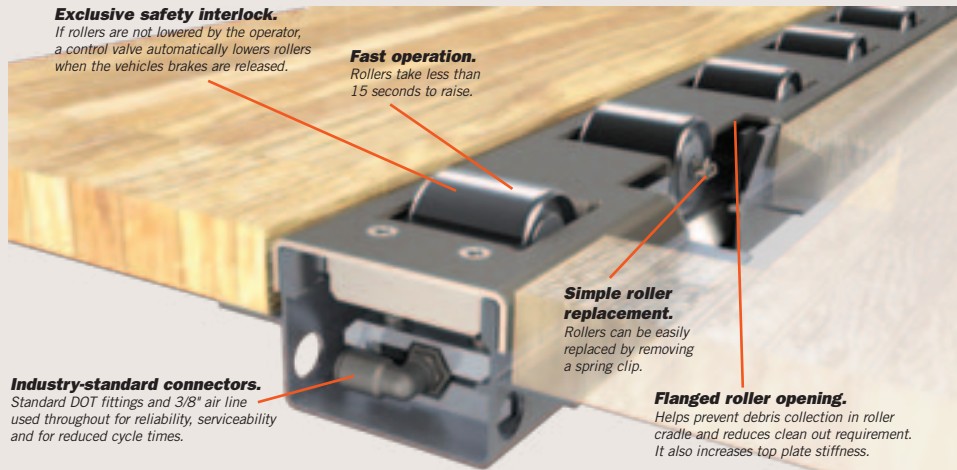

2" ROLLER CONFIGURATIONS

Wing Mount



Bottom Mount



Retract-A-Roll 4



Skate wheels have sealed bearings and 300 lb/ft (136 kg) per dual skate wheel.

The high-capacity skate wheels have lower rolling resistance and longer lifespan. A 5-lane system will do the same work as a 6-lane Retract-A-Roll 2 system.

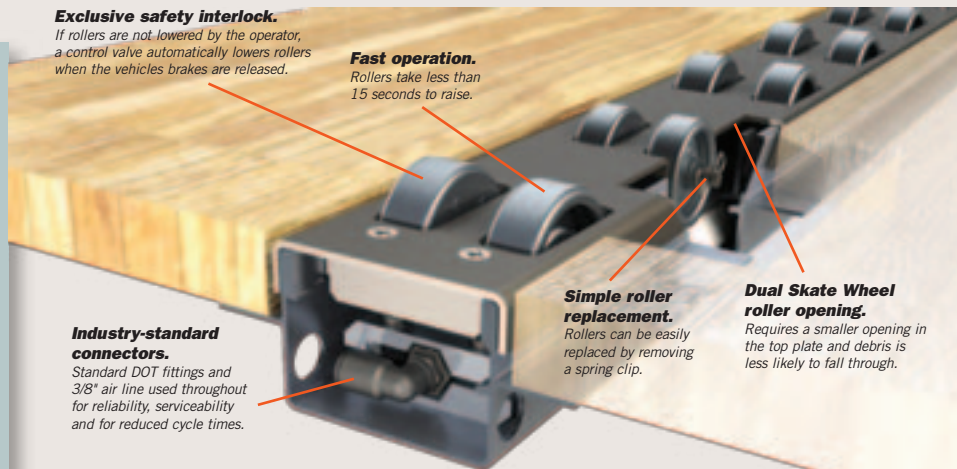

SKATE WHEEL CONFIGURATIONS

Wing Mount



Bottom Mount



INTERIOR VAN SOLUTIONS

THE RIGHT TRACK

Ankra Series E, A and F Track were designed to team with Ankra end fittings, Beam Sockets, and Decking/Shoring Beams for the strongest, most reliable support. Constructed of steel or aluminum and available in 10' lengths as standard, other lengths available upon request. To withstand corrosion, Ankra galvanized track has a G-90 hot dip finish with a surface chemical treatment. Painted track is finished with either high-quality, powder coat or semi-gloss enamel. Custom lengths and special finishes available, contact Customer Service Department.

Reference TTMA RP No. 47 for installation. Attach track using screws, rivets or by welding. Contact vehicle manufacturer or qualified installer to determine fastener size and mounting method. **WARNING:** Welding of galvanized material may emit toxic fumes. Please use caution and proper ventilation.

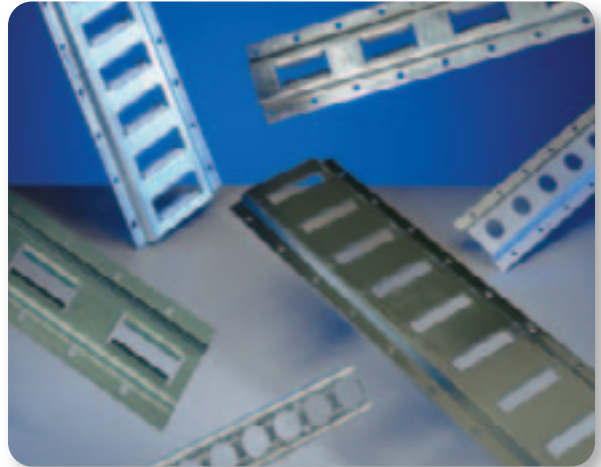

LOGISTIC TRACK

Series E

Series E track is made of high strength 12-gauge steel for Series E end fittings, Beam Sockets and Decking/Shoring Beams.

HORIZONTAL

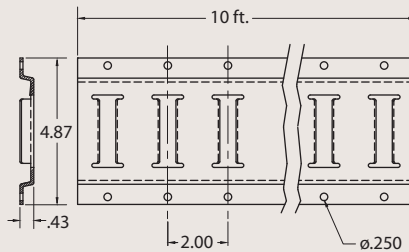
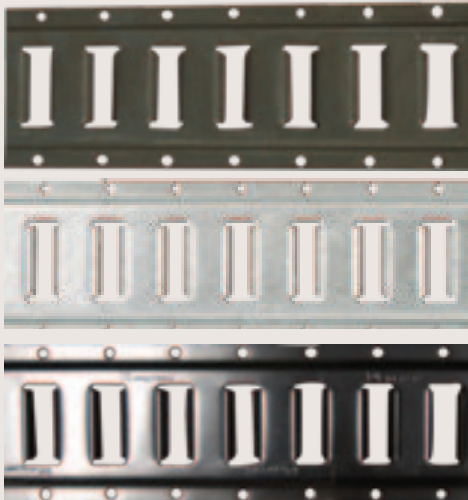

48117-25-120.00

Gray Powdercoat. Weight/Length: 16.6 lbs./10 ft. 7.5 kg./3 m

48117-25-60.00

Gray Powdercoat. Weight/Length: 8.3 lbs./5 ft. 3.77 kg./1.5 m

48117-21-120.00

Galvanized. Weight/Length: 17.2 lbs./10 ft., 7.80 kg./3 m

48117-21-60.00

Galvanized. Weight/Length: 8.6 lbs./5 ft. 3.90 kg./1.5 m

48117-32-120.00

Black Powdercoat Weight/Length: 16.6 lbs./10 ft., 7.5 kg./3 m

VERTICAL

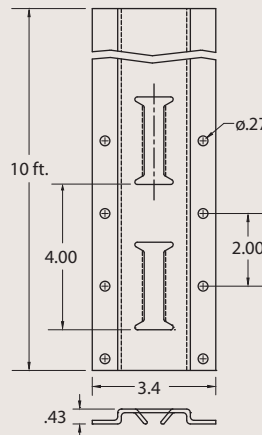

40838-10

Gray Powdercoat. Weight/Length: 13.5 lbs./10 ft. 6.1 kg./3 m

40838-11

Galvanized. Weight/Length: 14 lbs./10 ft. 6.4 kg./3 m

LOGISTIC TRACK

Series A

Series A track, made of high strength steel or 6061 T6 aluminum, is designed for Series E end fittings, Beam Sockets and Decking/Shoring Beams.

HORIZONTAL

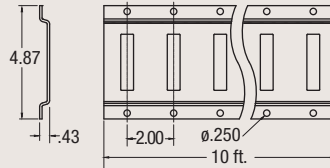

42948-10

Gray Powdercoat.
Weight/Length: 15.0 lbs./10 ft.,
6.8 kg./3 m. 12-gauge.

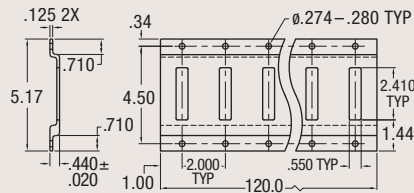

49359-10

Aluminum.
Weight/Length: 8 lbs./10 ft.,
3.6 kg./3 m.
Special Lengths Available.

SERIES E & A TRACK END CAPS

Designed to be used with either series E or A track to close the track end which would otherwise be exposed, allowing cargo to get snagged on open edges. Beveled edge of the plastic end caps eliminates any tearing or snagging when loading cargo against the trailer wall. Simply place end caps against the edges of either E or A Track and secure.



End Cap



E-Track



A-Track

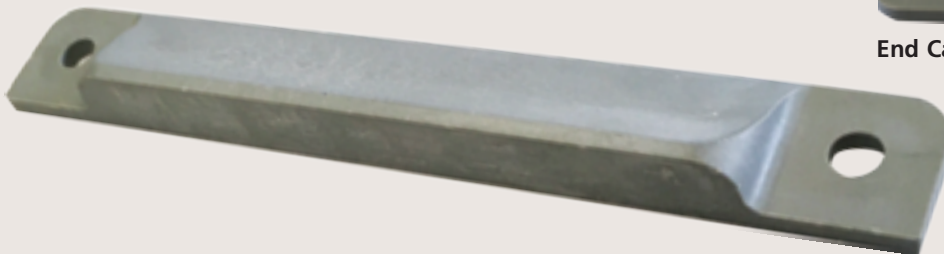

46006-11

Series E & A Track
End Caps
Size: 5.17" w x .73" h

Series F

Series F track is made of high strength steel for F end fittings and Shoring Beams.

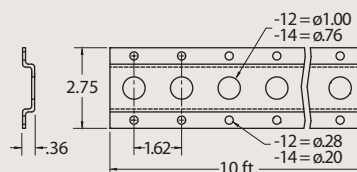

40849-12

Galvanized. 1.62 in. hole spacing &
1" hole dia. (Canada) Weight/length:
6.0 lbs./10 ft., 2.7 kg./3 m. 14-gauge.

40849-14

Galvanized. 1.62 in. hole spacing &
3/4" hole dia. (USA) Weight/length:
6.0 lbs./10 ft., 2.7 kg./3 m. 15-gauge.

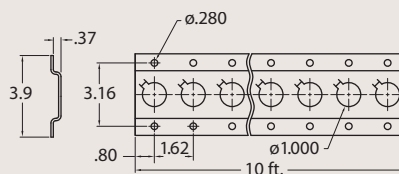

49313-13

Galvanized. 1.62 in. hole spacing &
1" hole dia. (Canada) Weight/length:
12.2 lbs./10 ft., 5.53 kg./3 m.
12-gauge.

INTERIOR VAN SOLUTIONS

LOGISTIC TRACK

Tether Track



310R-120

Galvanized Steel Tether Track.
Weight/Length: 13.4 lbs./10ft., 6.0 kg/3 m.
Special Lengths Available.

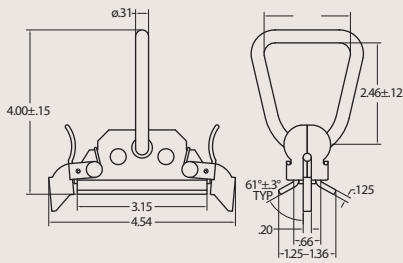
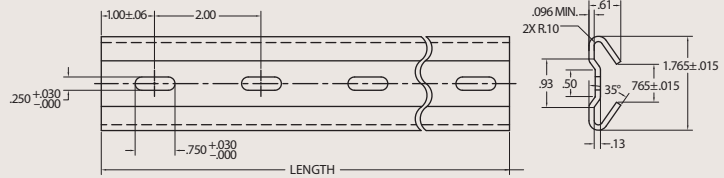

50149-10

Captive Tether Fitting used for the 310R Track. WLL: 1,000 lbs./453.5 kg.

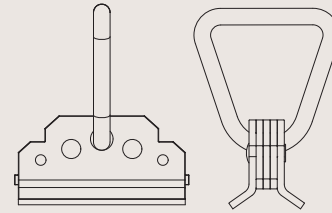

50149-11

Non-Locking Sliding Tether Fitting used for 310R Track. WLL: 1,000 lbs./453.5 kg.

Series F Channel

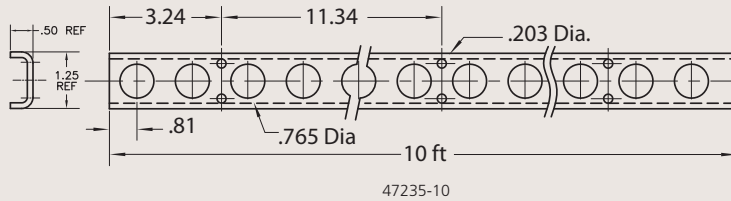

47235-10

Galvanized. 1.62 in. hole spacing & .765" hole diameter.
Weight/Length: 9.0 lbs./10 ft., 4.05 kg./3 m.

BEAMS, BARS & HOOPS

All the innovation and selection you'll ever need. Ankra gives you a choice of shoring beams with steel, aluminum, or heavy-duty aluminum models. Aluminum beams feature a patented flat latch mechanism that eliminates the age old problem of damaged trigger mechanisms. It's easier to release, even while wearing gloves. There is even a replacement flat latch channel assembly that can be used to update your existing beams. Extend beam life and keep your costs low.

STANDARD-DUTY ALUMINUM SERIES E AND A DECKING/SHORING BEAM WITH PATENTED FLAT LATCH

Decking and Shoring WLL: 2,200 lbs./999 kg.*

PATENTED

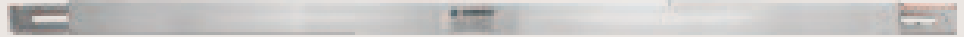
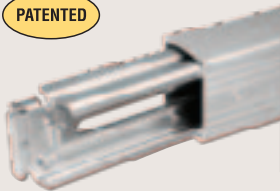

43638-50

Adjustable Range/Weight:
84.7 – 95.6 in./16.0 lbs./7.3 kg.

43638-51

Adjustable Range/Weight:
92.9 – 103.8/18.8 lbs./8.5 kg.

WIDE TOP ALUMINUM SERIES E AND A DECKING BEAM WITH PATENTED FLAT LATCH

Decking WLL: 3000 lbs./1363 kg*

PATENTED

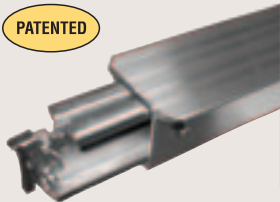

50158-10

Wide Top Decking Beam with textured, 4-1/2" top surface to increase contact area for cargo on the beam deck. Adjustable Range/Weight: 92.9-103.8 in./26.4 lbs./12.0 kg. Decking WLL: 3,000 lbs. not recommended for shoring. Patented Flat Latch.

HEAVY-DUTY ALUMINUM SERIES E AND A BEAM ASSEMBLY WITH PATENTED FLAT LATCH

Decking WLL: 3,000 lbs./1,363 kg.* Shoring WLL: 2,500 lbs./1,136 kg.*

PATENTED

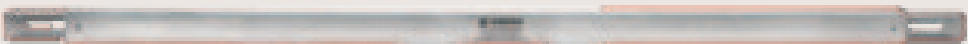
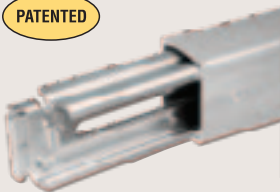

49039-50

Adjustable Range/Weight:
84.7 – 95.6/
20.5 lbs./9.3 kg.

49039-51

Adjustable Range/Weight:
92.9 – 103.8/
22.5 lbs./10.2 kg.

49039-52

Adjustable Range/Weight:
96.0 – 106.9/
24.5 lbs./11.0 kg.

SERIES E AND A STEEL DECKING/SHORING BEAM WITH TRIGGER LATCH

Decking WLL: 2,000 lbs./900 kg. Shoring WLL: 1,100 lbs./499 kg.*

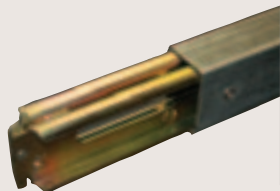

49360-13

Adjustable Range/Weight: 92.1 – 102.9 in./39 lbs./17.7 kg. 14 gauge steel.
Decking WLL: 2,000 lbs./907 kg.

DECKING BEAM HOOPS

47670-10

Designed to help restrain the movement of packages of cargo within your truck or trailer. Two hoops and attachment hardware are included providing easy mounting. For 43638, 49039 and 49360 series E and A Decking/Shoring Beams. Weight: 13.25 lbs./6.01 kg.

*Working Load Limit (WLL) rating is 1/3 of breaking strength with evenly distributed load. Never exceed trailer manufacturer decking load limits. Do not create an unstable, top heavy trailer. Load heavier items on trailer floor.

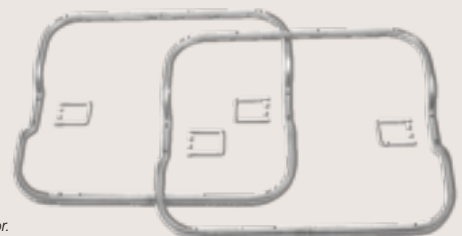

INTERIOR VAN SOLUTIONS

BEAMS, BARS & HOOPS

REPLACEMENT PARTS

PATENTED

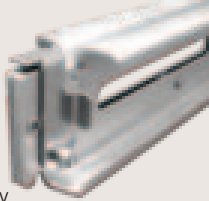

43627-13

Replacement Channel Assembly with patented flat latch. 11 Gauge. Weight: 3.8 lbs./1.73 kg. For aluminum beams 43638, 49039 and 50158. Can be retrofitted into conventional trigger style beams.



50194-100

Low Profile Allen Sleeve Nut and Bolt Kit. Low profile allen head bolt and sleeve nut with a semi-flush head height of .10". Used for attaching channel assemblies to beams. The bolt has a self locking patch to prevent loosening due to vibration. For 43638, 49039, 49360, 49414, 50080, 50158, 50186, 50191 and 50420 beams. Weight: .10 lb./5 kg.

PATENTED

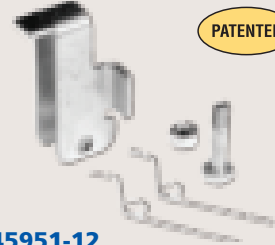

45951-12

Flat Latch Repair Kit Includes latch, screw, nut, springs and instructions. Weight: .14 lb./06 kg. For Part No. 43627-13 channel assembly.

BEAM SOCKETS — For use with standard commercial grade Douglas Fir 2-in. x 6-in. lumber. PLEASE NOTE: The working load limit of lumber varies widely.



40921-10

Standard Beam Socket. Weight: .70 lb./32 kg.



40921-11

Heavy-Duty Beam Socket. Internally welded plate for added strength. Weight: .85 lb./39 kg.

SHORING BARS – F SERIES WITH NEW EASY PUSH BUTTON DESIGN



49439-10

Round Shoring Bar. Steel. Adjustable in 2" increments to 117". Weight: 20.0 lbs./9.1 kg. Shoring WLL: 500 lbs./227 kg. Recommended installed length: 81" – 117". Outer tube diameter: 1.66" Inner tube diameter: .72" 3/4" hole dia. (USA)

49439-11

Round Shoring Bar. Steel. Adjustable in 2" increments to 117". Weight: 20.0 lbs./9.1 kg. Shoring WLL: 500 lbs./227 kg. Recommended installed length: 81" – 117". Outer tube diameter: 1.66" Inner tube diameter: .945" 1" hole dia. (Canada)

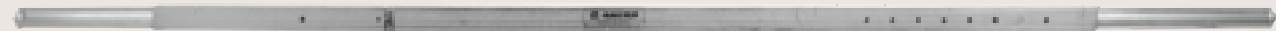

49439-20

Square Shoring Bar. Steel. Adjustable in 2" increments to 117". Weight: 28.0 lbs./12.71 kg. Shoring WLL: 1,000 lbs./454 kg. Recommended installed length: 81" – 117". Tube size 2" square. Inner tube diameter: .72" 3/4" hole dia. (USA)

49439-21

Square Shoring Bar. Steel. Adjustable in 2" increments to 117". Weight: 28.0 lbs./12.71 kg. Shoring WLL: 1,000 lbs./454 kg. Recommended installed length: 81" – 117". Tube size 2" square. Inner tube diameter: .945" 1" hole dia. (Canada)

**Working Load Limit (WLL) rating is 1/3 of breaking strength with an evenly distributed load.*

CARGO STA® BARS

ALUMINUM STANDARD CARGO STA®



43782-15 6061 T6 Aluminum
Length/Weight: 89.75 – 104.5 in. 8.95 lbs./4.07 kg.
Long Tube Diameter: 1.50 in.

STEEL CARGO STA®



48407-10 Galvanized Steel Tubing
Length/Weight: 89.75 – 104.5 in. 11.72 lbs./5.33 kg.
Long Tube Diameter: 1.50 in.

CARGO STA® AND JACK BAR REPLACEMENTS



Foot, Adjustable End (short)

43781-15S
2 in. x 4 in. Bolt-on.
Weight: .78 lb./0.36 kg.
For 43782-15, 48407-10.

43781-17
4 in. x 4 in. Bolt-on.
Weight: 1.35 lbs./0.61 kg.
For 49205-25, 49205-26,
49205-27, 49205-31.



Foot, Fixed End (long)

43781-14S
2 in. x 4 in. Bolt-on.
Weight: .62 lb./0.29 kg.
For 43782-15, 48407-10.

43781-16
4 in. x 4 in. Bolt-on.
Weight: 1.1 lbs./0.5 kg.
For 49205-25, 49205-26,
49205-27, 49205-31.

KITS FOR CARGO STA®



49443-10 Housing, Rack and Lever Assembly
For Cargo Sta 43782-15, 48407-10.
Complete with necessary hardware.
Weight: 2.12 lbs./0.97 kg.



49400-10 38" Red Handle Assembly

Jack Bar Component Kit

Complete kit consisting of a Jack Assembly Housing, 4" x 4" adjustable end foot, 4" x 4" fixed end foot and all necessary hardware.

49400-10 Red Handle for 49205-26, 49205-27 & 49205-31 Jack Bars.

INTERIOR VAN SOLUTIONS

HEAVY-DUTY JACK BARS

Jack Bars feature 4" x 4" bolt-on feet assemblies and are designed for use in general duty cargo applications. They feature 1-1/2" square heavy-gauge, galvanized steel tubing with a cycle tested, heavy duty automotive jack assembly. The jack mechanism includes a quick release feature that allows the bar to be quickly retracted for easy removal. For ease of recognition, bars with the longest adjustment range have red handles.

HEAVY-DUTY ONE-PIECE GALVANIZED

PATENTED



49205-25 Weight: 16.2 lbs./7.35 kg. Adjustment range: 85.0" – 104.0" Black Handle

49205-26 Weight: 16.6 lbs./7.54 kg. Adjustment range: 85.0" – 114.0" Red Handle

HEAVY-DUTY ONE-PIECE GALVANIZED WITH HOOPS



49205-27 Weight: 20.0 lbs./9.08 kg. Adjustment range: 85.0" – 114.0" Red Handle

UNIVERSAL JACK BAR

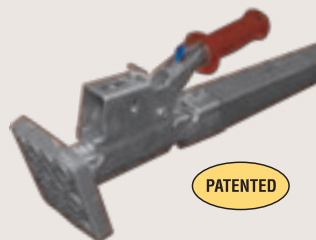

PATENTED



49205-31

Weight: 18.2 lbs./8.26 kg.

- 51" size used to restrain half loads; compact to fit in locked tool box
- Useful in various load configurations through the universal design
- Patented Safety Snap Pin



Fully Retracted

Adjustment Range: 51" – 80"



Mid Extension

Adjustment Range: 70" – 99"



Full Extension

Adjustment Range: 85" – 114"

CAUTION:

Due to variations in trailer wall construction, Cargo Sta® and Jack Bars do not have rated Working Load Limits. Read and follow instructions on bar labels.

ACCESSORIES

BAR KEEP™ CARGO BAR HOLDER

Constructed of high quality steel and finished with black powder coating for corrosion resistance. Holds two standard or heavy-duty cargo bars. A built in gasket reduces vibration and rattle while protecting the bars. Accommodates both 2" x 4" or 4" x 4" feet.

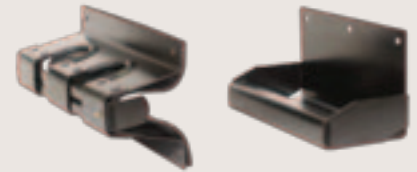

49348-11 Weight: 6.68 lbs./3.03 kg.

DOOR PULL STRAPS

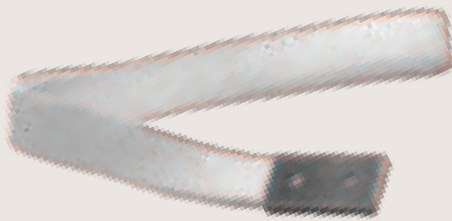

For pulling overhead, and side doors and wheel carts. Rust protected galvanized steel clip is pre-punched for easy installation.

49015-18 18-in. Door Pull Strap. Weight: .20 lb./0.09 kg.
49015-24 24-in. Door Pull Strap. Weight: .30 lb./0.14 kg.
49015-36 36-in. Door Pull Strap. Weight: .40 lb./0.18 kg.

10788-10 Door Pull Strap.

WLL: 500 lbs./227 kg. Weight: 1.6 lbs./0.72 kg

Allows the driver to close the roll-up door while standing on the ground.

- ▶ Black wear sleeve protects the elastic section
- ▶ Easily installs into existing logistics post or E track of the sidewall and the inside of the rear roll up door.



TIE OFFS A convenient way to attach rope or web to trailer side wall.



40386-10

Series E and A Rope Tie Off 3-piece end fitting for use with Series E or A Track. WLL: 1,000 lbs./454 kg. Weight: .30 lb./0.14 kg.



40386-12

Series F Rope Tie Off. For use with Series F Track USA. WLL: 500 lbs./225 kg. Weight: .30 lb./0.14 kg.

40386-13

For use with Series F Track Canada. WLL: 500 lbs./225 kg. Weight: .30 lb./0.14 kg.



40386-11

Series E and A Rope Tie Off Spring actuated fitting for use with Series E or Series A Track. WLL: 1,333 lbs./605 kg. Weight: .40 lbs./0.18 kg.



49542-10

Series E and A Fitting w/ D-Ring. WLL: 1,000 lbs./454 kg. Weight: .34 lb./0.15 kg.



47772-12

Series E and A Track Fitting w/ Round Ring. WLL: 1,000 lbs./454 kg. Weight: .45 lb./0.20 kg.



50115-10

Heavy-Duty Series E and A Track Fitting w/ Round Ring. Heat treated. WLL: 2,000 lbs./908 kg. Weight: .40 lbs./0.18 kg.



50115-11

Heavy-Duty Series E and A Track Fitting w/ D-Ring. Heat treated. WLL: 2,000 lbs./908 kg. Weight: .40 lbs./0.18 kg.

ACCESSORIES

TRUCK & TRAILER FITTINGS

Designed for low-profile mounting in trucks and trailers, the Recessed Pan Fitting is tensioned to reduce ring movement, but allows easy lifting. The Stake Pocket Anchor can be surface or flush mounted and accepts roll cart lock pins.



45545-15

With black trim collar.
WLL: 530 lbs./240 kg.
Weight: .30 lb./14 kg.

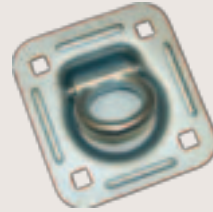

45849-15

Recessed Pan Fitting
WLL: 1,666 lbs./757 kg.
Weight: 1.20 lbs./55 kg.

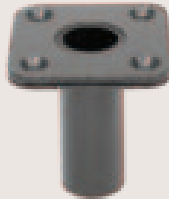

49371-10

Stake Pocket Anchor.
Conforms to USPS drawing
B-13956. Black Lacquer Finish.
Weight: 0.98 lb./44 kg.

RELEASABLE TRAILER DOOR STRAP

10285-10

If cargo has shifted against the swing doors during transit, they may swing open suddenly when the lock bar is released, dumping cargo out of the trailer. With Ancra's NEW Releasable Trailer Door Limit Strap, drivers can safely recover from shifted freight by pulling the 10-foot paracord feature out of harm's way.

FEATURES & BENEFITS

- ▶ S-hooks are carbon steel with a yellow chromate finish
- ▶ The hooks are inserted into the lock bars on each door to limit the opening of the door
- ▶ 10-ft. yellow paracord can be pulled safely out of harm's way, allowing the driver to safely open the swing doors upon cargo shifting while in transit
- ▶ Paracord can be wound and placed on top of webbing and conveniently secured by velcro while not in use
- ▶ 1000 lb. WLL hook with keeper
- ▶ 37-inch length from hook to hook
- ▶ Safety yellow webbing for high visibility

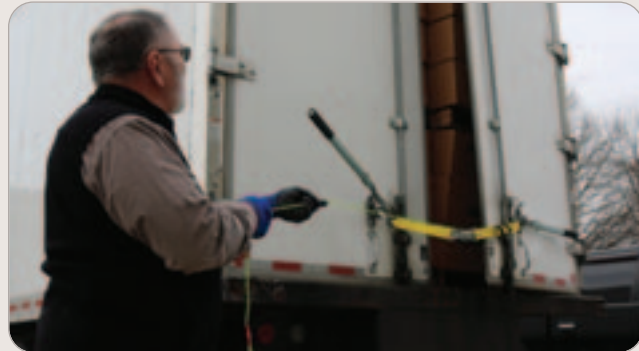

ACCESSORIES

TRAILER DOOR LIMIT STRAP

10924-10 Designed to be used when opening swing doors.

- ▶ If cargo has shifted against the doors during transit, they may swing open suddenly when the lock bar is released, dumping cargo out of the trailer and causing injury
- ▶ The hooks are inserted into the lock tabs on each door before opening to limit the motion of the door
- ▶ 800 lbs./363 kg. WLL hook with keeper
- ▶ 32-inch length from hook to hook



DRIVER ASSIST STRAPS

Helping Hand. Ancra's Driver Assist Straps lend a hand to drivers and dock workers climbing into and out of trailers. The 36-inch strap with a reinforced 12-inch loop handle connects to existing E or A track, offering a convenient handgrip for a more secure entry and exit. Now available with two hand loops for added stability, the straps are assembled with high strength components for a rated user weight limit of 320 lbs.

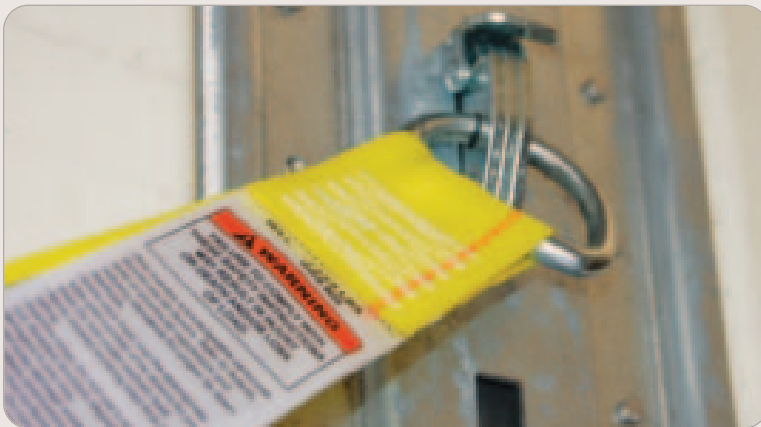

10902-11PK Single Loop (Retail Packaged)



10902-21 Dual Loop

TENSION-LIMITING RATCHET ASSEMBLIES

No more overtightening

You can prevent damage caused by over tightened ratchet buckles with the Tension-Limiting Ratchet Buckle. Ancra's innovative buckle will tighten to no more than 300 pounds of tension. It's enough force to secure the cargo, but not enough to damage your vehicle. Not even your strongest driver can apply too much force.

How it works

Once the strap is installed in the track, ratchet the strap normally. When proper tension is reached, the handle releases and no more tension can be applied. Even if you try, you can never go too tight. Assemblies are available with Low Profile or Heavy-Duty long handle buckles. There are six Torque-Limiting Ratchet Straps available in lengths from 12 to 20 feet.



Series E Heavy-Duty Buckle Strap w/ Spring E Fitting
Heavy-duty 12,000 lbs. yellow latex treated polyester webbing.
WLL: 1,333 lbs./605 kg. Fixed End: 48-in.

Part No.	Strap Length	Weight
49021-30	12 ft.	4.00 lbs.
49021-31	16 ft.	4.25 lbs.
49021-32	20 ft.	4.50 lbs.



Series E Low Profile Buckle Strap w/ Spring E Fitting
Strong 6,000 lbs. polyester webbing.
WLL: 1,333 lbs./605 kg. Fixed End: 48-in.

Part No.	Strap Length	Weight
48672-33	12 ft.	2.50 lbs.
48672-34	16 ft.	2.65 lbs.
48672-35	20 ft.	2.80 lbs.

LOGISTIC STRAPS & ASSEMBLIES

Ancra logistic straps are available in cam buckle and ratchet buckle models with end hardware to suit your specific application. Made with strong polyester webbing, they are color coded to easily identify the length. The standard fixed end length for all straps is 48". Built on a reputation for dependability and strength, these strap assemblies promise the quality that comes with every product that bears the Ancra name.



CAM BUCKLE STRAP ASSEMBLIES

6,000 lb. Polyester Webbing (47200) with a Cam Buckle (40880-15). The adjustable end of the straps are captivated to prevent them from pulling out of the buckle and separating.

SERIES E STRAP ASSEMBLY Working Load Limit: 833 lbs./378 kg.



Series E Assembly with spring actuated end fitting



Part No.	Strap Length	Weight
40602-17	12 ft.	1.65 lbs.
40602-18	16 ft.	1.80 lbs.
40602-19	20 ft.	1.95 lbs.



Series E Assembly with 3-piece end fitting



Part No.	Strap Length	Weight
40602-10	12 ft.	1.55 lbs.
40602-11	16 ft.	1.70 lbs.
40602-12	20 ft.	1.85 lbs.

SERIES F STRAP ASSEMBLY (USA) Working Load Limit: 500 lbs./225 kg.



For use with USA type 3/4" dia. hole F track



Part No.	Strap Length	Weight
40602-20	12 ft.	2.40 lbs.
40602-21	16 ft.	2.55 lbs.
40602-22	20 ft.	2.70 lbs.

SERIES F STRAP ASSEMBLY (CANADA) Working Load Limit: 500 lbs./225 kg.



For use with Canada type 1" dia. hole F track



Part No.	Strap Length	Weight
40602-103	12 ft.	2.40 lbs.
40602-104	16 ft.	2.55 lbs.
40602-105	20 ft.	2.70 lbs.

Please note: Ancra logistics straps come in three webbing colors, coded according to lengths. 12 ft. webbing is yellow, 16 ft. webbing is gray, 20 ft. webbing is blue. End fitting part numbers are shown for reference only.

INTERIOR VAN SOLUTIONS

CAM BUCKLE STRAP ASSEMBLIES

ELECTRONIC STRAP ASSEMBLY Working Load Limit: 833 lbs./378 kg. Fixed Ends: 7-in. & 48-in.
6,000 lbs. polyester webbing 47200 and cam buckle 40880-19. Fixed End: 48-in.



Part No.	Strap Length	Weight
49025-20	12 ft.	1.90 lbs.
49025-21	16 ft.	2.05 lbs.
49025-22	20 ft.	2.20 lbs.

An additional E fitting allows for increased adjustability for various applications.

PLATE TRAILER STRAPS 6,000 lbs. polyester webbing 47200 and cam buckle 40880-19.

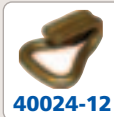

Part No.	Strap Length	Weight
48253-19	12 ft.	1.85 lbs.
48253-20	16 ft.	2.00 lbs.
48253-21	20 ft.	2.15 lbs.

Cam Buckle Strap w/ Wire Hook & Spring E Fitting
WLL: 833 lbs./378 kg.

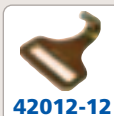

Part No.	Strap Length	Weight
48253-22	12ft.	2.00 lbs.
48253-23	16 ft.	2.15 lbs.
48253-24	20 ft.	2.30 lbs.

Cam Buckle Strap w/ F Hook & Spring E Fitting. Fixed End: 48-in.
WLL: 800 lbs./360 kg.



Part No.	Strap Length	Weight
40602-97	12ft.	1.50 lbs.
40602-98	16 ft.	1.65 lbs.
40602-99	20 ft.	1.80 lbs.

Cam Buckle Strap w/ Wire Hooks. Fixed End: 48-in.
WLL: 500 lbs./225 kg.

RATCHET BUCKLE STRAP ASSEMBLIES

RATCHET BUCKLE STRAPS Working Load Limit: 1,333 lbs./605 kg. Fixed End: 48-in.



Series E Ratchet Buckle Strap w/ 47608-21 Spring End Fitting

6,000 lb. polyester webbing 47200 and low profile ratchet buckle 44258-13 for durability and wear.

Part No.	Strap Length	Weight
48672-13	12 ft.	2.25 lbs.
48672-14	16 ft.	2.40 lbs.
48672-15	20 ft.	2.55 lbs.



Series E Heavy-Duty Ratchet Buckle Strap w/ 47608-21 Spring End Fitting
WLL: 1,333 lbs./605 kg. Fixed End: 48-in.

Heavy-duty 12,000 lb. yellow polyester webbing 41632-13 and standard handle ratchet buckle 44627-11 for durability and wear. All yellow straps.

Part No.	Strap Length	Weight
49021-20	12 ft.	3.50 lbs.
49021-21	16 ft.	3.75 lbs.
49021-22	20 ft.	4.00 lbs.

PLATE TRAILER STRAPS 6,000 lbs. polyester webbing 47200 and low profile ratchet buckle 44258-13. Fixed End: 48-in.



Ratchet Buckle Strap w/ Wire Hook & Spring E Fitting
WLL: 833 lbs./378 kg.



Part No.	Strap Length	Weight
48253-13	12 ft.	2.50 lbs.
48253-14	16 ft.	2.65 lbs.
48253-15	20 ft.	2.80 lbs.



Ratchet Buckle Strap w/ F Hook & Spring E Fitting
WLL: 800 lbs./360 kg.

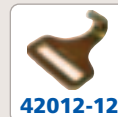

Part No.	Strap Length	Weight
48253-16	12 ft.	2.70 lbs.
48253-17	16 ft.	2.85 lbs.
48253-18	20 ft.	3.00 lbs.



Ratchet Buckle Strap w/ Wire Hooks
WLL: 500 lbs./225 kg.



Part No.	Strap Length	Weight
48672-22	12 ft.	2.00 lbs.
48672-23	16 ft.	2.15 lbs.
48672-24	20 ft.	2.30 lbs.

INTERIOR VAN SOLUTIONS

TIE DOWN STRAPS & ASSEMBLIES

CUSTOM NETS

Ankra custom solutions promise quality and performance.

Designed for your particular application, Ankra custom nets offer retention support for various sized and shaped packages. Using strong 1" or 2" webbing, they're individually tailored to fit your loading condition, assuring maximum effectiveness in transporting a load securely.

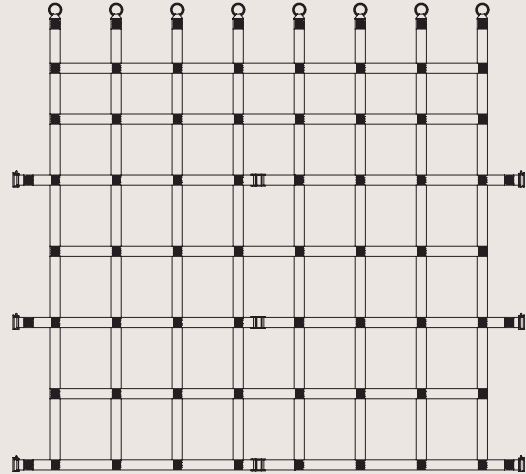
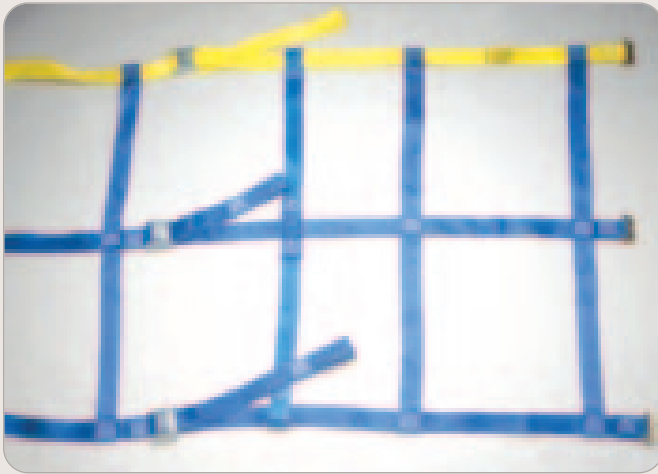

FOR MORE INFORMATION ON CUSTOM APPLICATION CONTACT YOUR ANKRA CUSTOMER SERVICE REPRESENTATIVE @ 1-800-233-5138

MOBILE APP

Poly Deckboard Calculator

Input Data in Yellow Fields Below		Load Sample Data	Other Data	Physical increase	
		Plywood	Poly Deckboard	Per Deckboard	Per Year
Number of Trucks/Trailers	100	100		Physical increase lbs	400
Boxes Per Truck/Trailer	20	20		Annual investment payment lbs	8000
Costs per board - volume discounts may apply on PWB cost	\$15.00	\$20.00		Actual increased revenue	\$1400
Maintenance included (excluding out of pocket) Per deckboard per day	5	5		Poly Deckboard VALUE	
Maintenance rate \$/hr	\$40.00	\$40.00		Increase payload amount	\$140
Costs per week per truck/trailer	10	10		Board cost savings amount	\$120
Number of weeks per year in operation	50	50		Maintenance cost reduction amount	\$1400
Percentage of loads at maximum weight	70%	70%		TOTAL ANNUAL VALUE	\$1670
Dollars per ton of payload	\$5.00	\$5.00			\$16700
Weight lbs	20	21			
Average Service Life months	12	12			
Initial investment	\$10000	\$11000			
Strap value @ \$3.00 per PWB	\$0	\$6000			
Annual board expense	\$10000	\$0			

See how Ankra's Poly Deckboard Calculator can help your fleet maximize ROI.



Scan this QR Code to go to our website at <https://www.ancracargo.com/poly-deckboard-calculator>

SAFETY AND EMERGENCY EQUIPMENT

Like all Ancra products, our line of safety and emergency equipment is engineered with an understanding of your requirements and our ongoing commitment to your safety. Our safety products carry the assurance of dependability Ancra is known for, offering the best in flags, banners, lights, reflectors and wearables.

- All Ancra flags and banners meet FMCSA 393.87 standards
- Durable, reversible banners are now available with sewn-in bungee cords for convenience and ease of use.
- Emergency lights and reflective warning equipment have been introduced to assist you on the road.



SAFETY AND EMERGENCY EQUIPMENT

SAFE TRAVELS

Keeping you safe and your cargo secure, Ancra has introduced an extended line of safety and emergency equipment. Our flags, banners, lights, reflectors and wearables complement our existing safety products to bring you more flexibility and convenience while protecting you against hazards on the road.



SAFETY PRODUCTS

Flags & Banners

Meet FMCSA 393.87 standards.



49893-10
Fluorescent Red Heavy-Duty Mesh Flag w/ wooden dowel. 18" x 18"



49893-11
Red Cotton Flag w/ 7 Gauge Wire w/ 1/2" loop. 18" x 18"

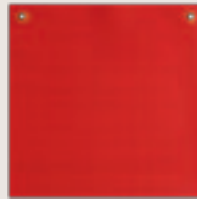

49893-12
Fluorescent Red Mesh Flag w/ 2 brass grommets. 18" x 18"

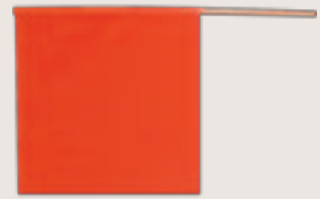

49893-13
Fluorescent Orange Mesh Flag w/ wooden dowel. 18" x 18"



49893-14
Fluorescent Orange Mesh Flag w/ 2 brass grommets. 18" x 18"



49893-15
Red Cotton Flag w/ 3/4" x 30" wooden dowel. 18" x 18"

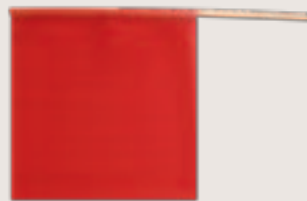

49893-16
Red Jersey Mesh Flag w/ 3/4" x 30" wooden dowel. 18" x 18"



49893-17
Red Jersey Mesh Flag w/ 7 Gauge Wire w/ 1/2" loop. 18" x 18"



49893-18
Fluorescent Orange Mesh Flag w/ 7 Gauge Wire w/ 1/2" loop. 18" x 18"



49893-19
Orange Jersey Mesh Flag w/ 7 Gauge Wire w/ 1/2" loop. 18" x 18"

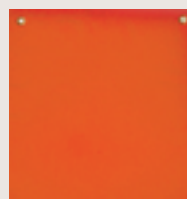

49893-20
Orange Cotton Fabric Flag w/ 2 brass grommets. 18" x 18"



50430-10
Magnetic Flag Holder
Secure warning flags with 2.3" diameter ceramic magnet rated at 80-lb. pull force. Holder has center screw and wing nut for flag attachment. Nylon insert prevents wing nut from backing off during transport.

SAFETY PRODUCTS

Flags & Banners



49894-10

Double-sided banner reads WIDE LOAD and OVERSIZED LOAD. Made of durable vinyl fabric and comes with six grommets and four 44" attachment ropes. 84" x 18" Tri-lingual package.



49894-11

Double-sided banner reads WIDE LOAD and OVERSIZED LOAD. Made of durable vinyl fabric and comes with sewn-in ropes top and bottom, plus six grommets. 84" x 18" Tri-lingual package.



49894-12

Double-sided banner reads WIDE LOAD and OVERSIZED LOAD. Made of durable vinyl fabric and comes with six grommets and four 44" attachment ropes. 72" x 14" Tri-lingual package.



49894-13

Mesh OVERSIZED LOAD banner. Made of woven polyester mesh with six grommets and four 44" attachment ropes. 84" x 18" Tri-lingual package.



49894-14

Mesh WIDE LOAD banner. Made of woven polyester mesh with six grommets and four 44" attachment ropes. 84" x 18" Tri-lingual package.

49894-15

OVERSIZE LOAD and WIDE LOAD reversible banners with sewn-in bungee cords to eliminate the need for additional ropes or cords to attach banner. 6 grommets, 84" x 18"



Canada D Signs



49895-10

Canadian D sign is made of durable vinyl fabric. Comes with 10 grommet attachment points. 96" x 12"

REFLECTIVE SIGNS



49895-11

Reflective Canadian D Sign with 10 grommets. 96" x 12"

49895-12

Reflective Canadian D Sign with 10 grommets. 96" x 18"

49895-13

Reflective Canadian D Sign with 10 grommets, reverse side: Oversize Load. 96" x 18"

SAFETY AND EMERGENCY EQUIPMENT

EMERGENCY EQUIPMENT

Reflectors



50434-10 **Triangle Warning Kit**

Certified by AMECA and DOT and in compliance with FMCSA standards, Ancra's 3 collapsible reflective triangles come in a durable red plastic carrying case. Includes trilingual set-up and proper usage instructions to be in compliance with FMCSA.

Wearables



50435-L **50435-XL** **Reflective Work Gloves w/split leather palm and fingers**

Two sizes Large and XL work gloves with breathable, high-visibility cloth back and retro-reflective strips.



50435-3T-L **50435-3T-XL**

Insulated Reflective Work Gloves

Fully lined with 3M Thinsulate, gloves with high visibility cloth back and retro-reflective strips are available in Large and XL.



AUTO 'TRANSPORT' SOLUTIONS

Whether transporting a load of cars or someone's pride and joy, you depend on proven quality restraint products. Ancra designs and manufactures auto transport products, strap assemblies, harnesses and hardware to meet your most demanding requirements. We're committed to offering you the quality you demand.



AUTO 'TRANSPORT' SOLUTIONS

TIE DOWNS & ACCESSORIES

CAR HAULER RATCHET STRAPS WLL: 3,333 lbs./1,515 kg. using 41632-46 yellow latex treated polyester webbing and 47105-11 Short Wide Handle Ratchet Buckle. Available with 43120-13 Wire Hooks or 49914-11 Low Profile Swivel J Hooks. Straps include 2 rubber tread cleats.



50179-10

2" x 102" Ratchet Strap w/ Wire Hooks. Weight 5 lbs./2.3 kg.



50179-11

2" x 102" Ratchet Strap w/ Low Profile Swivel J Hook. Weight 6.1 lbs./2.8 kg.

AUTO HAULER WINCH STRAP



48487-24

2" x 140" Winch Strap w/ cleats

The auto tie down strap goes over the tire and utilizes three cleated rubber pads that mesh with the tread to keep the strap centered and secured. Weight 1.9 lbs./.86 kg.

SINGLE CLEAT

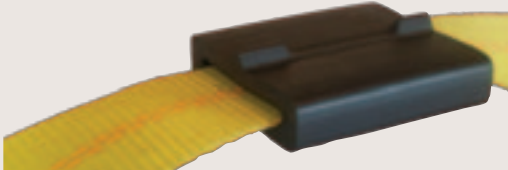

48485-11

Rubber tread cleat for Auto Hauler Winch Strap. Used with 2-inch webbing to secure strap to vehicle tire. Length: 3.0-in. Width: 2.8-in. Weight: .20 lbs./0.09 kg.

TIE DOWN W/ SNAP HOOKS Working Load Limit: 1,666 lbs./757 kg. using 41632-13 yellow latex treated polyester webbing, a 47105-11 Short Wide Handle Ratchet Buckle and 40084-14 Snap Hooks.



Part No.	Strap Length	Weight	Fixed End
49020-20	6 ft.	3.80 lbs./1.73 kg.	6 in.
49020-21	8 ft.	4.44 lbs./2.02 kg.	8 in.
49020-22	12 ft.	4.84 lbs./2.20 kg.	12 in.

Ankra's tie downs feature yellow latex treated polyester webbing (41632-13) with Ratchet Buckle (47105-11) and Snap Hook (40084-14).

'TIE DOWNS & 'TRANSIT' STRAPS

ANTIQUE & RACE CAR TIE DOWNS



30AS33-BK

2" x 33" Black Axle Strap w/ sleeve. Individually display packaged. WLL: 3,300 lbs./1,498 kg. Weight .5 lbs./23 kg.



500-C8-RD

2" x 8' Red Ratchet Strap w/ Twisted Snap Hooks. WLL: 3,300 lbs. Weight 5 lbs./2.3 kg.

DOLLY STRAPS Ancra designs and manufactures a complete line of wheel straps for automobile-towing dollies. Three of the more popular designs are shown here. Call us about your specific requirements.



BASKET STRAP

45143-20

for tires 7"W x 20"H
Weight: 2.25 lbs./1.02 kg.
WLL: 1,666 lbs./755 kg.

45143-22

for tires 8"W x 24"H
Weight: 2.5 lbs./1.14 kg.
WLL: 1,666 lbs./755 kg.

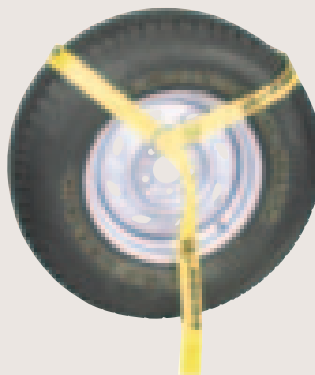

WHEEL DOLLY STRAP

47934-11

2" x 86" with Round Ring
for tires 8"W x 22"H
Weight: 1.0 lbs./46 kg.
WLL: 900 lbs./410 kg.



WHEEL DOLLY STRAP

47935-11

with S Hooks
for tires 10"W x 24"H
Weight: 1.5 lbs./46 kg.
WLL: 800 lbs./360 kg.

47935-12

with Spring E Fittings
for tires 10"W x 24" H
Weight: 1.5 lbs./46 kg.
WLL: 1,300 lbs./590 kg.

SERIES E TRANSIT STRAP W/ RTJ HOOKS



49023-20

6-foot Strap

49023-21

8-foot Strap

49023-22

12-foot Strap

Working Load Limit: 1,000 lbs./454 kg. Fixed End: 14"

Assembled with durable latex treated polyester webbing (41632-13) and Ratchet Buckle (47105-11). Fixed end features a heavy-duty Series E & A Track Fitting (47772-12), and the adjustable end features a Cluster Hook (45515-10) with R,T, and J Hooks.

AUTO 'TRANSPORT' SOLUTIONS

'TIE DOWNS & 'TRANSIT' STRAPS

ADJUSTABLE TIRE BONNETS



30ATB Adjustable Tire Bonnet

for 13" – 17" OEM Tires.
WLL: 1,000 lbs./454 kg.
Weight 3 lbs./1.4 kg.



30RT Double Adjustable Tire Bonnet

for 10" – 22" Wide Tires.
WLL: 3,333 lbs./1,515 kg.
Weight 6 lbs./2.7 kg.

LASHING WINCHES

The lashing winch with double hex drive can be bolted or welded to the trailer like a standard winch, yet offers the quick release and easy operation of a ratchet buckle.

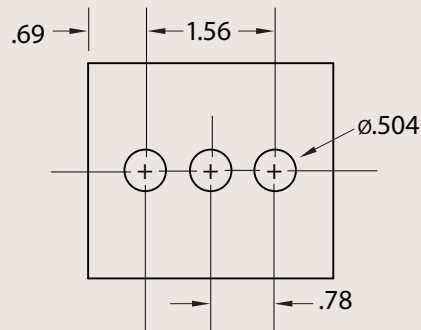
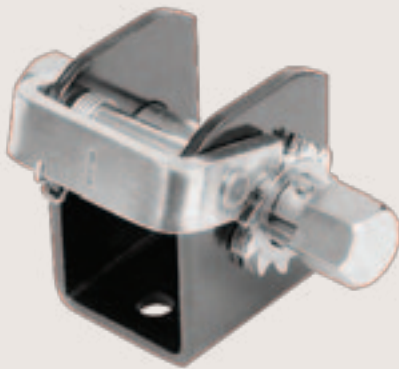

47640-31

With double hex drive and three mounting holes.
WLL: 3,333 lbs./ 1,515 kg.
Weight: 3.8 lbs./1.7 kg.

LIFTING SOLUTIONS

Trust Ancra's slings for your lifting and rigging needs. Our durable polyester round slings and eye to eye web slings come in a full range of lengths and widths for your application.



LIFTING SOLUTIONS

GET A LIFT FROM ANCRA'S SLINGS

Flexible and resistant to abrasion, Ancra's line of durable polyester round slings and polyester twisted eye to eye slings are built for strength and durability. Round slings are color-coded by width from 1" to 7". Eye to eye web slings are available in 1", 2", 3" and 4" web widths in single- and double-ply models. Custom sizes and models may be available. For details, contact Ancra Customer Service Department at 800-233-5138.

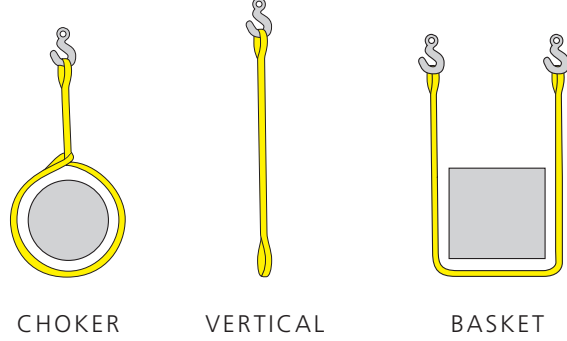

ROUND SLINGS

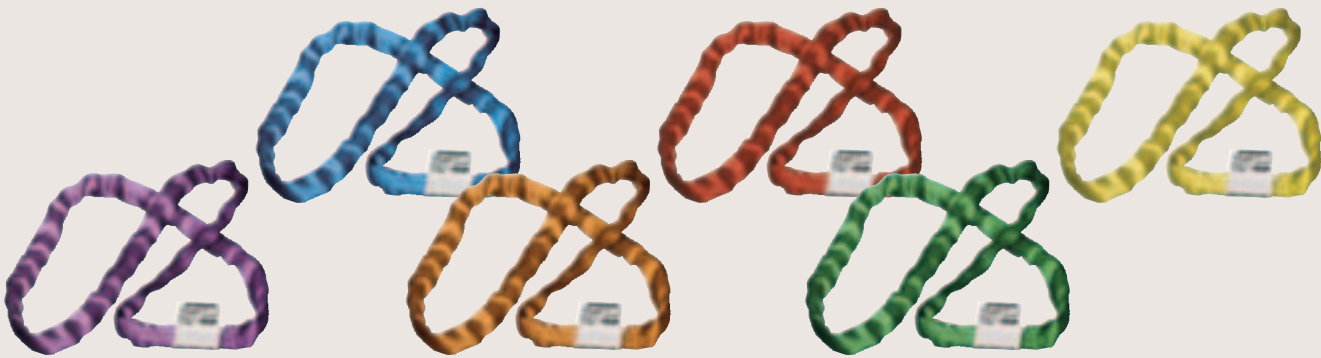

LIFTING SLINGS — ROUND

Part No.	Description	Choker	Vertical	Basket
20-ENR1X3	1" x 3' Purple Endless Round Sling	2,100	2,600	5,200
20-ENR1X4	1" x 4' Purple Endless Round Sling	2,100	2,600	5,200
20-ENR1X6	1" x 6' Purple Endless Round Sling	2,100	2,600	5,200
20-ENR1X8	1" x 8' Purple Endless Round Sling	2,100	2,600	5,200
20-ENR1X12	1" x 12' Purple Endless Round Sling	2,100	2,600	5,200
20-ENR2X3	2" x 3' Green Endless Round Sling	4,200	5,300	10,600
20-ENR2X4	2" x 4' Green Endless Round Sling	4,200	5,300	10,600
20-ENR2X8	2" x 8' Green Endless Round Sling	4,200	5,300	10,600
20-ENR2X12	2" x 12' Green Endless Round Sling	4,200	5,300	10,600
20-ENR2X20	2" x 20' Green Endless Round Sling	4,200	5,300	10,600
20-ENR3X3	3" x 3' Yellow Endless Round Sling	6,700	8,400	16,800
20-ENR3X4	3" x 4' Yellow Endless Round Sling	6,700	8,400	16,800
20-ENR3X8	3" x 8' Yellow Endless Round Sling	6,700	8,400	16,800
20-ENR3X12	3" x 12' Yellow Endless Round Sling	6,700	8,400	16,800
20-ENR3X20	3" x 20' Yellow Endless Round Sling	6,700	8,400	16,800
20-ENR4X10	4" x 10' Tan Endless Round Sling	8,500	10,600	21,200
20-ENR4X16	4" x 16' Tan Endless Round Sling	8,500	10,600	21,200
20-ENR5X4	5" x 4' Red Endless Round Sling	10,600	13,200	26,400
20-ENR5X6	5" x 6' Red Endless Round Sling	10,600	13,200	26,400
20-ENR5X12	5" x 12' Red Endless Round Sling	10,600	13,200	26,400
20-ENR5X20	5" x 20' Red Endless Round Sling	10,600	13,200	26,400
20-ENR7X6	7" x 6' Blue Endless Round Sling	17,000	21,200	42,400

POLYESTER TWISTED EYE TO EYE WEB SLINGS

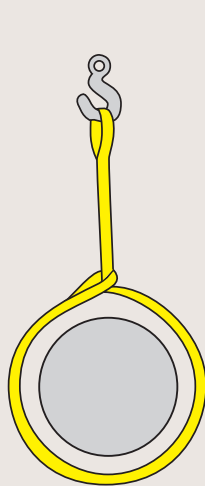

CHOKER



VERTICAL

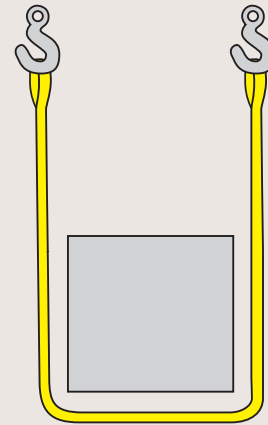

BASKET



- ▶ Light Weight & Economical
- ▶ 9,800 lbs. Polyester Webbing
- ▶ Single-Ply & Double-Ply Styles
- ▶ Industry Compliant Sewn In Warning Tags
- ▶ Reinforced Eyes
- ▶ Tapered Eyes on 2", 3", & 4" Widths
- ▶ Complies with WSTDA — WS-1-Type IV CL7 Web Slings

SINGLE-PLY 9,800 LB. TWISTED EYE TO EYE SLING

Part No.	Size	Choker	Vertical	Basket
20-EE1-9801X3	1" x 3'	1,250	1,600	3,200
20-EE1-9801X4	1" x 4'	1,250	1,600	3,200
20-EE1-9801X6	1" x 6'	1,250	1,600	3,200
20-EE1-9801X10	1" x 10'	1,250	1,600	3,200
20-EE1-9802X3	2" x 3'	2,450	3,100	6,200
20-EE1-9802X4	2" x 4'	2,450	3,100	6,200
20-EE1-9802X6	2" x 6'	2,450	3,100	6,200
20-EE1-9802X10	2" x 10'	2,450	3,100	6,200
20-EE1-9802X12	2" x 12'	2,450	3,100	6,200
20-EE1-9802X14	2" x 14'	2,450	3,100	6,200

POLYESTER TWISTED EYE TO EYE WEB SLINGS

DOUBLE-PLY 9,800 LB. TWISTED EYE TO EYE SLING

Part No.	Size	Choker	Vertical	Basket
20-EE2-9801X4	1" x 4'	2,450	3,100	6,200
20-EE2-9801X8	1" x 8'	2,450	3,100	6,200
20-EE2-9802X3	2" x 3'	4,950	6,200	12,400
20-EE2-9802X4	2" x 4'	4,950	6,200	12,400
20-EE2-9802X6	2" x 6'	4,950	6,200	12,400
20-EE2-9802X8	2" x 8'	4,950	6,200	12,400
20-EE2-9802X10	2" x 10'	4,950	6,200	12,400
20-EE2-9802X12	2" x 12'	4,950	6,200	12,400
20-EE2-9802X16	2" x 16'	4,950	6,400	12,400
20-EE2-9802X20	2" x 20'	4,950	6,200	12,400
20-EE2-9802X30	2" x 30'	4,950	6,200	12,400
20-EE2-9803X10	3" x 10'	7,000	8,800	17,600
20-EE2-9803X12	3" x 12'	7,000	8,800	17,600
20-EE2-9803X16	3" x 16'	7,000	8,800	17,600
20-EE2-9803X20	3" x 20'	7,000	8,800	17,600
20-EE2-9804X6	4" x 6'	8,800	11,000	22,000
20-EE2-9804X8	4" x 8'	8,800	11,000	22,000
20-EE2-9804X10	4" x 10'	8,800	11,000	22,000
20-EE2-9804X12	4" x 12'	8,800	11,000	22,000
20-EE2-9804X16	4" x 16'	8,800	11,000	22,000
20-EE2-9804X20	4" x 20'	8,800	11,000	22,000
20-EE2-9804X30	4" x 30'	8,800	11,000	22,000

WARNING:

Please read and comply with all warnings on labels and safety bulletins included with each sling. Failure to do so may result in serious property damage, and/or personal injury or death!

DO NOT exceed the rated capacity shown on the package and label attached to the sling.

For Operating and Inspection Manuals for synthetic Web Slings, see the Web Sling and Tie Down Association Publication WSTDA-WS-1.

For Operating and Inspection Manuals for polyester Round Slings, see the Web Slings and Tie Down Association Publication WSTDA-RS-1.

UTILITY TIE DOWNS

Ankra offers high quality restraint products for both commercial truckers and consumers. For transporting motorcycles, ATVs, household furnishings or equipment, our utility strap assemblies are made of high strength steel components and durable materials. Look to Ancra for years of trouble free use.



UTILITY TIE DOWNS

UTILITY TIE DOWNS

Ancra Utility Tie Downs are versatile and reliable for securing a wide range of light to medium duty cargo. Made of high-strength steel and abrasion-resistant webbing, they're quick and easy to use for secure performance in recreational, light industrial, and agricultural applications.

MINI RATCHET STRAP



Ratchet strap with Wire Hooks and floating D-Ring for use together or separately. Fixed End: 23" Individually display packaged.

43887-10 1" x 16'
Weight: 1.56 lbs./71 kg.

43887-11 1" x 20'
Weight: 1.69 lbs./77 kg.

45988-15 1" x 9'
Weight: 1.33 lbs./60 kg.
Bulk WLL: 1,000 lbs./454 kg.

HEAVY-DUTY RATCHET STRAP ASSEMBLY



44340-11
1" x 10' Ratchet strap with Wire Hooks for multipurpose use.
WLL: 1,000 lbs./454 kg.
Weight: 1.60 lbs./73 kg.

ANCRA RED UTILITY STRAP



41048-10
1" x 5.5' Cam buckle strap with vinyl-coated S Hooks.
Fixed End: 6-in.
WLL: 400 lbs./181 kg.
Weight: 1.60 lbs./73 kg.

MULTI-PACK CONSUMER TIE DOWNS

RATCHETING TIE DOWNS

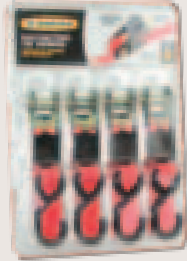

49368-10 1" x 15' 4-pack
1" red Ratchet strap with vinyl-coated S Hooks secures cargo, equipment and household furnishings.
Weight: 4.7 lbs./2.14 kg.
WLL: 266 lbs./121 kg.

CAM BUCKLE TIE DOWNS



95001 1" x 8' 2-pack
1" Cam strap with vinyl-coated S Hooks. Packaged in an interactive package.
Weight: 1.85 lbs./84 kg.
WLL: 400 lbs./181 kg.

RATCHETING TIE DOWNS

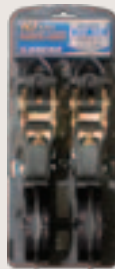

95002 1" x 10' 2-pack
1" black Ratchet straps with vinyl-coated S Hooks in an interactive package.
Weight: 2.25 lbs./1.0 kg.
WLL: 550 lbs./250 kg.

RATCHETING TIE DOWNS

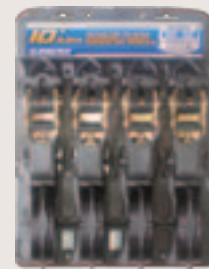

95005 1" x 10' 4-pack
1" black Ratchet straps with vinyl-coated S Hooks in an interactive package.
Weight: 4.6 lbs./2.1 kg.
WLL: 550 lbs./250 kg.

RATCHETING TIE DOWNS

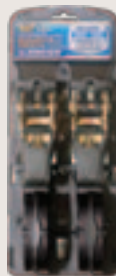

95007 1" x 12' Endless Loop, 2-pack, 1" Ratchet straps in an interactive package.
Weight: 1.75 lbs./.79 kg.
WLL: 550 lbs./250 kg.

RETRACTABLE RATCHETING TIE DOWNS



95370 1" x 6' 2-pack
1" black Retractable Ratchet straps with scratch-resistant vinyl-coated S Hooks in an interactive package.
Weight: 3.20 lbs./1.45 kg.
WLL: 500 lbs./227 kg.

UTILITY TIE DOWNS

PICKUP TRUCK CARGO NETS



SHORT BED PICKUPS

50199-10

For short beds - 72" W x 80" L

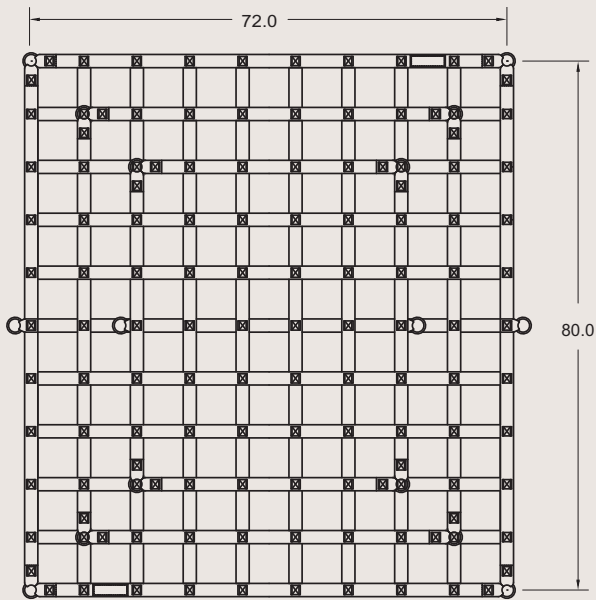

LONG BED PICKUPS

50199-11

For standard beds - 72" W x 96" L

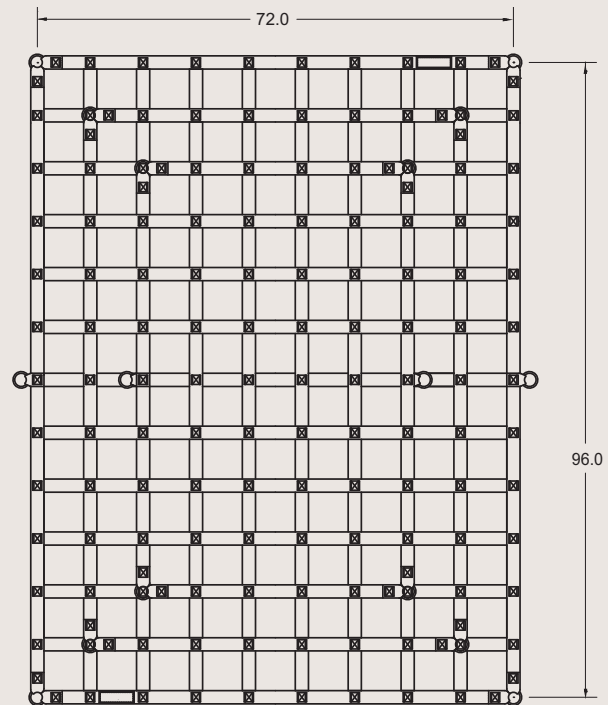

D-Rings and Connectors are spaced to accommodate various heights of loads. Each net comes with six (6), 1-1/4" x 5' long straps with a die cast cam buckle. Each strap has vinyl-coated S hooks with wire keepers to prevent them from disengaging.

Net openings: 6.0"
WLL: 1,200 lbs./540 kg.

GENERAL HARDWARE & WEBBING

We make them tough. Buckles, hooks, rings, track fittings and attachment hardware are made from high-strength steel. Webbing is abrasion-resistant, a trademark of Ancra quality. Standard or custom, these products are the core of Ancra's first-rate reputation.

- Quality materials and solid steel construction ensures long life
- Positive locking feature on tensioning hardware for security
- Wide assortment of hardware and webbing to suit your application
- Protective coatings for improved corrosion resistance

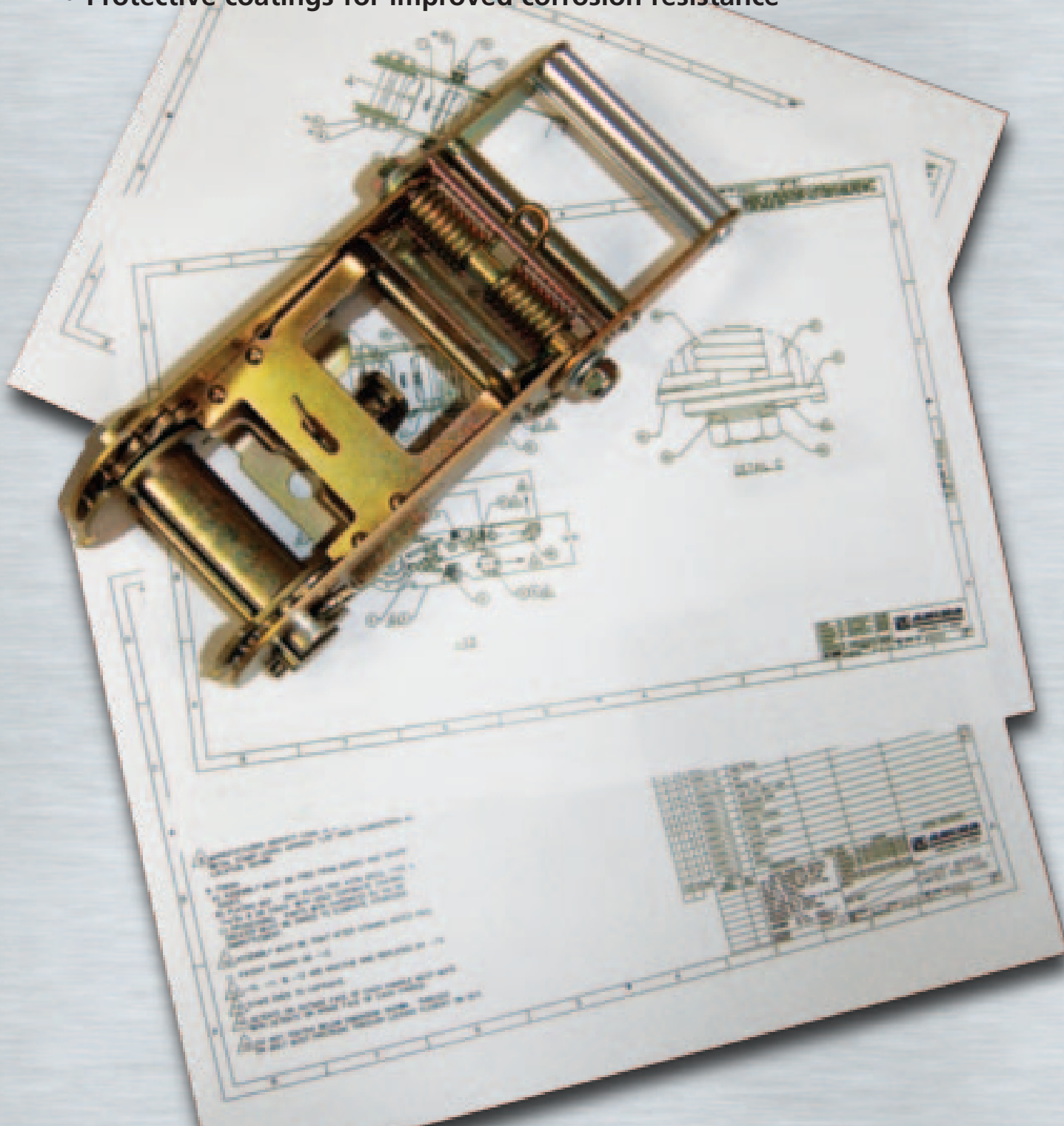

GENERAL HARDWARE & WEBBING

ANCRA BUCKLE QUALITY –

The standard of the industry, Ancra's durable buckles are designed with a unique latch and fast release cam that reduces sprocket wear. Our broad line of steel Ratchet, Cam and Overcenter Buckles meets your wide ranging load requirements, offering quick and easy release and secure locking tension. The popular and often copied long, wide-handle ratchet is a classic example of Ancra innovation. Our locking mechanism guards against vibration release, the 1.5-inch longer handle increases leverage by 20%, and the wider handle and latch design allows more hand room for easier operation. What began as innovation, is now the standard of the industry.



RATCHET BUCKLES

Ancra Ratchet Buckles are available in a wide range of models for 1-inch to 4-inch webbing widths. The buckles have a locking latch that engages when the handle is closed and prevents the inadvertent release of tension when under load. The handle cross pin interlocks with the frame, maintaining a low profile design. A removable rear bolt on most models allows for in field conversion or repair.

1-INCH

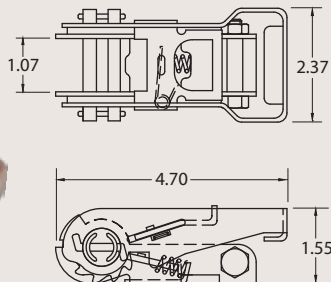

43320-32

WLL: 1,466 lbs./666 kg.
Weight: .76 lb./34 kg.

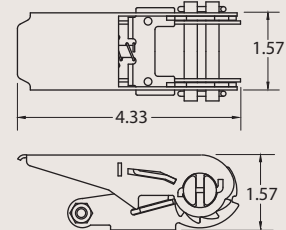

48770-10

Low profile, black powder coat
WLL: 500 lbs./227 kg.
Weight: .50 lb./22 kg.

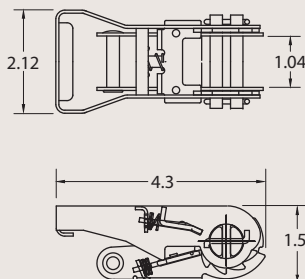

44232-10

WLL: 400 lbs./181 kg.
Weight: .50 lb./22 kg.

1 3/4-INCH

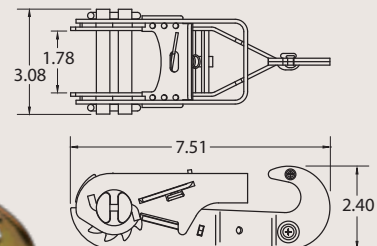

41808-14

1 3/4-in. Hook End
WLL: 2,000 lbs./908 kg.
Weight: 1.65 lbs./75 kg.

RATCHET BUCKLES

2-INCH

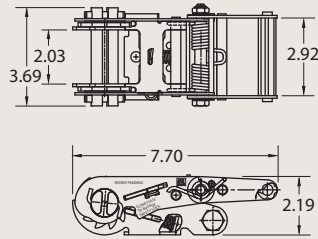

49410-13

Low Profile Torque Limiting. Reduces trailer damage by limiting overzealous tensioning. See page 65.

WLL: 3,666 lbs./1,663 kg.

Weight: 2.7 lbs./1.23 kg.

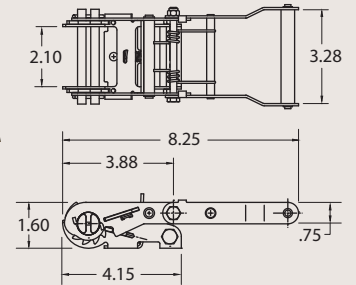

49715-10

Long Wide Handle Torque Limiting. Reduces trailer damage by limiting overzealous tensioning. See page 65.

WLL: 1,500 lbs./680 kg.

Weight: 1.56 lbs./.71 kg.

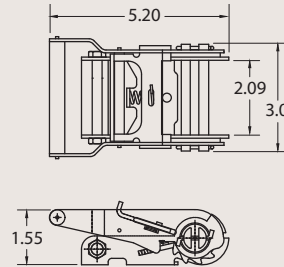

44258-13

Low Profile. Nut & bolt packaged separately.

WLL: 1,500 lbs./680 kg.

Weight: 1.30 lbs./.59 kg.

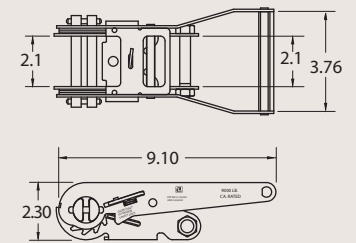

44587-10

Long Wide Handle

WLL: 3,666 lbs./1,666 kg.

Weight: 2.3 lbs./1.05 kg.

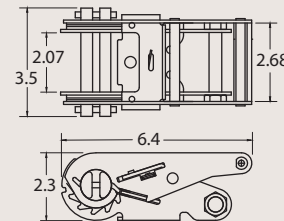

44627-11

Standard Handle

WLL: 3,333 lbs./1,515 kg.

Weight: 2.10 lbs./.95 kg.

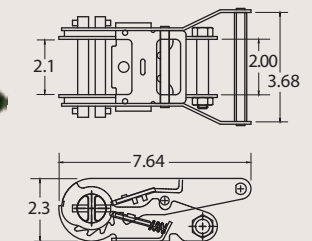

47105-11

Short Wide Handle

WLL: 3,666 lbs./1,666 kg.

Weight: 2.20 lbs./1.0 kg.

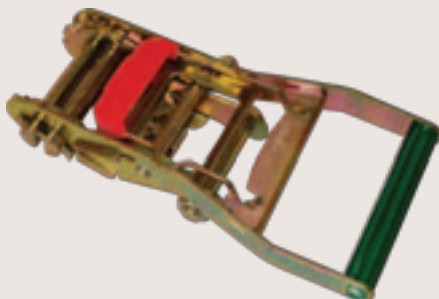

50037-10

Long Wide Handle Web Keeper Ratchet Buckle

WLL: 3,666 lbs./1,666 kg.

Weight: 2.35 lbs./1.07 kg.

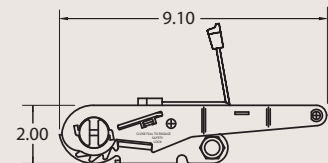
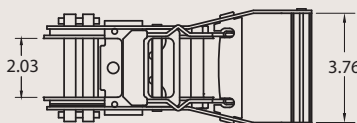

GENERAL HARDWARE & WEBBING

RATCHET BUCKLES

3-INCH

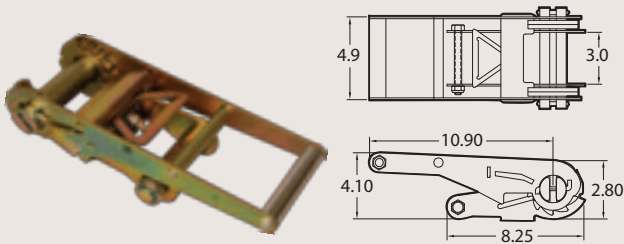

48965-10

WLL: 7,333 lbs./3,333 kg.

Weight: 7.0 lbs./3.18 kg.

4-INCH

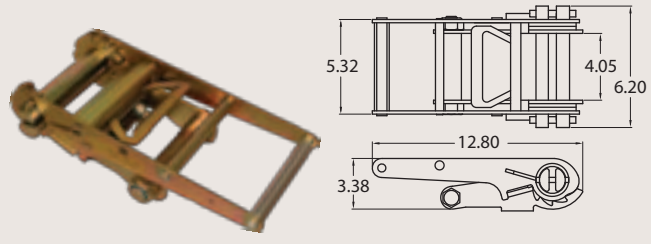

49349-10

WLL: 8,000 lbs./3,636 kg.

Weight: 8.0 lbs./3.63 kg.

OVERCENTER BUCKLES

Ankra Overcenter Buckles have one-piece steel frame construction. Designed for simple and easy operation. When attached to the strap, the webbing provides a pad between the buckle and the cargo.

1-INCH

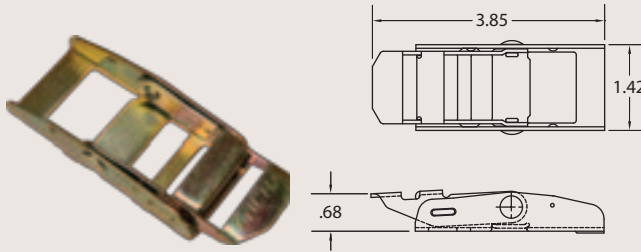

42816-18

WLL: 600 lbs./272 kg.

Weight: .15 lb./0.06 kg.

2-INCH

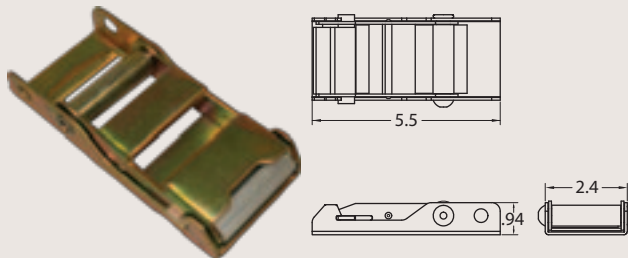

10135

WLL: 1,000 lbs./454 kg.

Weight: .8 lbs./0.36 kg.

1 3/4-INCH

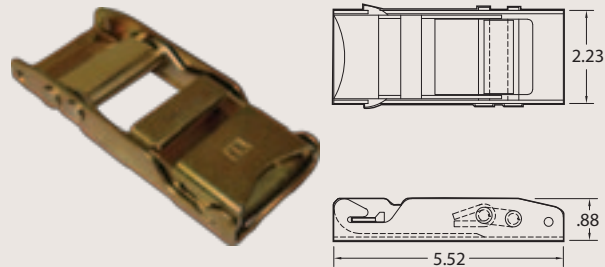

47800-10

WLL: 1,666 lbs./757 kg.

Weight: .70 lb./0.31 kg.

DID YOU KNOW?

In addition to the trucking industry, Ankra buckles are used in specialty markets that include aircraft, marine, automotive, material handling and military applications.

In each case, material specifications have been modified to give optimum performance for their specific use.

CAM BUCKLES

A one-piece frame design lengthens the service life of Ankra Cam Buckles. Quick and easy operation consists of simply pulling the handhold to tension and depressing the cam lever to release.

1-INCH

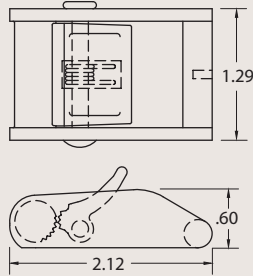

41030-12
WLL: 166 lbs./75 kg.
Weight: .13 lb./0.06 kg.

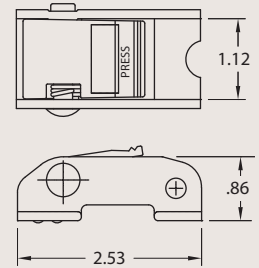

42195-11
WLL: 500 lbs./227 kg.
Weight: .25 lb./0.11 kg.

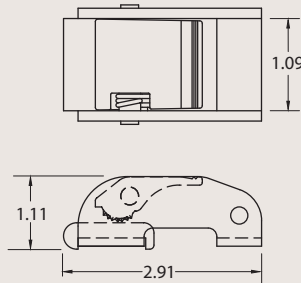

40880-22
WLL: 600 lbs./272 kg.
Weight: .40 lb./0.18 kg.

2-INCH

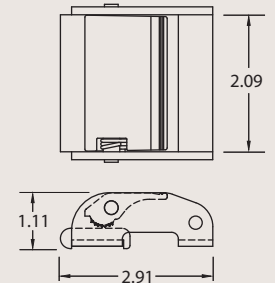

40880-15
WLL: 833 lbs./378 kg.
Weight: .69 lb./0.31 kg.

ROLLER BUCKLE

A simple slide bar adjuster buckle for light duty applications.

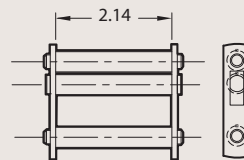

41645-10 Roller Buckle
WLL: 500 lbs./227 kg.
Weight: .20 lb./0.10 kg.

3-BAR SLIDE ADJUSTER

This adjuster is designed to be used for adjustment of strap lengths only, not for tensioning.

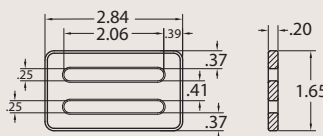
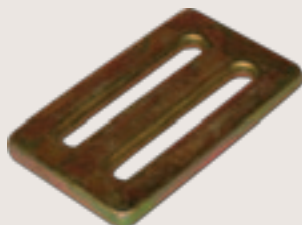

49834-10 3-Bar Slide Adjuster
WLL: 1,000 lbs./454 kg.
Weight: .30 lb./0.14 kg.

GENERAL HARDWARE & WEBBING

ATTACHMENT HARDWARE

Ankra hooks, rings and fittings are made to last. With heat treating and corrosion resistant plating or vinyl-coating, this quality line of attachment hardware is strong and durable.

WIRE HOOKS

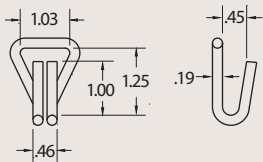

40316-12

1-inch Narrow Hook
WLL: 166 lbs./75 kg.
Weight: .10 lb./05 kg.

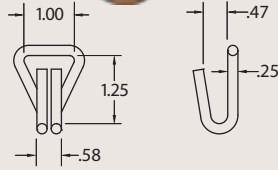

40024-10

1-inch Narrow Hook
WLL: 1,000 lbs./454 kg.
Weight: .10 lb./05 kg.

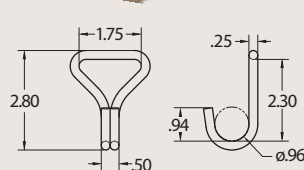

43120-19

1 3/4-inch Narrow Hook
WLL: 500 lbs./227 kg.
Weight: .17 lb./08 kg.

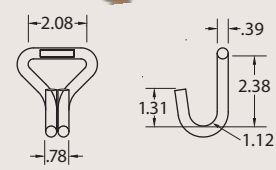

43120-11

2-inch Narrow Hook
WLL: 1,666 lbs./757 kg.
Weight: .39 lb./18 kg.

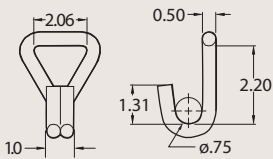

43120-13

2-inch Narrow Hook
WLL: 3,333 lbs./1,515 kg.
Weight: .62 lb./28 kg.

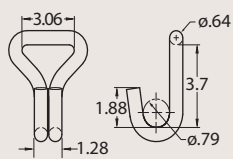

43120-20

3-inch Narrow Hook
WLL: 7,333 lbs./3,333 kg.
Weight: 1.39 lbs./63 kg.

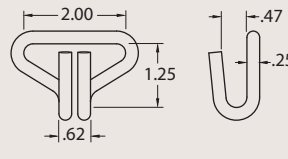

40024-12

2-inch Narrow Hook
WLL: 833 lbs./378 kg.
Weight: .10 lb./05 kg.

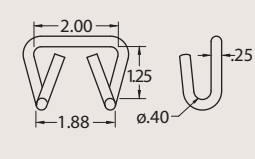

40023-12

2-inch Wide Hook
WLL: 833 lbs./378 kg.
Weight: .12 lb./06 kg.

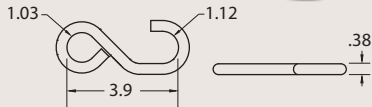

41313-12

Zinc-plated S Hook
WLL: 400 lbs./181 kg.
Weight: .28 lbs./13 kg.

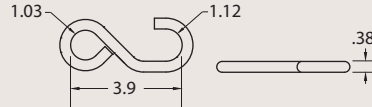

41313-13

1-inch Vinyl S Hook
WLL: 400 lbs./181 kg.
Weight: .29 lb./13 kg.

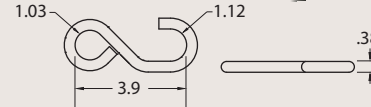

41313-19

1-inch Vinyl S Hook Heat Treated
WLL: 600 lbs./272 kg.
Weight: .30 lb./14 kg.

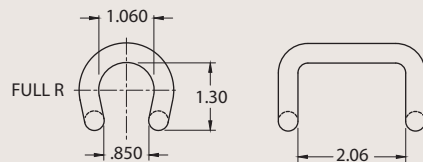

45228-10

Rave Hook
WLL: 1,167 lbs./530 kg.
Weight: .29 lb./13 kg.

ATTACHMENT HARDWARE

FLAT HOOKS

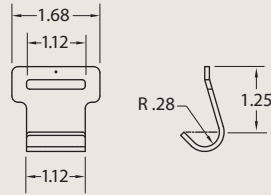

43546-10
1-inch Gutter Hook
WLL: 250 lbs./113 kg.
Weight: .05 lb./02 kg.

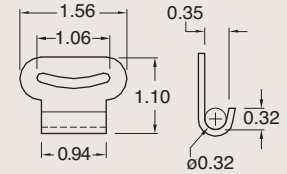

40065-10
1-inch Plated Flat Hook
WLL: 333 lbs./151 kg.
Weight: .04 lb./02 kg.

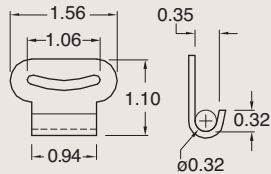

40065-12
1-inch Vinyl Flat Hook
WLL: 333 lbs./151 kg.
Weight: .05 lb./02 kg.

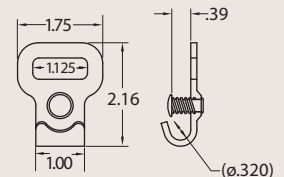

40044-10
1-inch Flat Hook with Keeper
WLL: 1,166 lbs./530 kg.
Weight: .68 lb./31 kg.

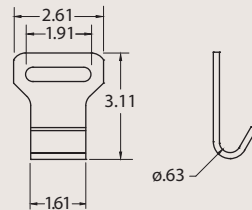

43099-10
2-inch Flat Hook
WLL: 1,666 lbs./757 kg.
Weight: .40 lb./18 kg.

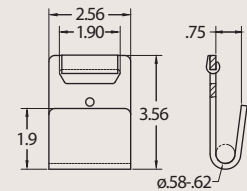

40891-18
2-inch Flat Hook
WLL: 3,333 lbs./1,515 kg.
Weight: .68 lb./31 kg.

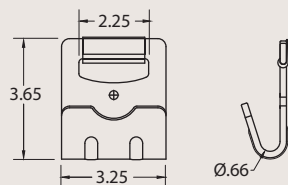

41766-18
3-inch Flat Hook
WLL: 5,400 lbs./2,450 kg.
Weight: .98 lb./45 kg.

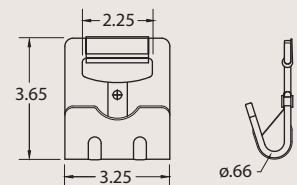

41766-19
3-inch Flat Hook with Keeper
WLL: 5,400 lbs./2,450 kg.
Weight: 1.03/47 kg.

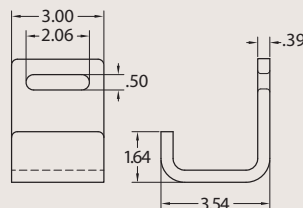

48968-11
2-inch Container Hook
WLL: 5,400 lbs./2,450 kg.
Weight: 2.0 lbs./91 kg.

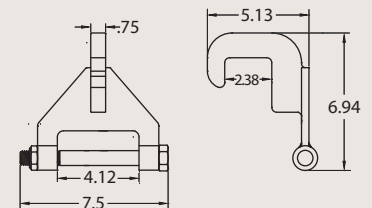

49770-10
4-inch Heavy-Duty Waste Hook
WLL: 5,100 lbs./2,313 kg.
Weight: 5.0 lbs./2.27 kg.

GENERAL HARDWARE & WEBBING

ATTACHMENT HARDWARE

SNAP HOOKS

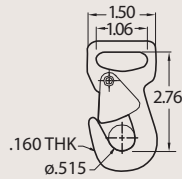

43044-10

1-inch Snap Hook
WLL: 1,666 lbs./757 kg.
Weight: .20 lb./.09 kg.

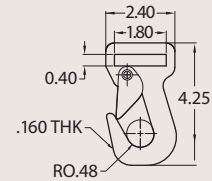

40084-14

2-inch Snap Hook
WLL: 2,100 lbs./953 kg.
Weight: .34 lb./.15 kg.

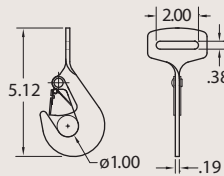

40758-11

2-inch Snap Hook w/ Satin Black Finish. Twisted Version
WLL: 3,333 lbs./1,515 kg.
Weight: .59 lb./.27 kg.

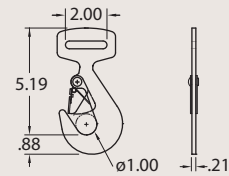

40758-13

2-inch Snap Hook w/ Satin Black Finish
WLL: 3,333 lbs./1,515 kg.
Weight: .59 lb./.27 kg.

RINGS

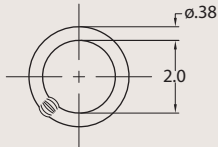

47944-10

Round Ring
WLL: 900 lbs./409 kg.
Weight: .25 lbs./.11 kg.

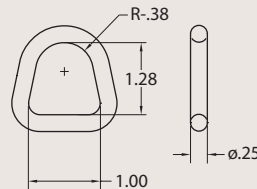

40025-10

1-inch D-Ring
WLL: 1,666 lbs./757 kg.
Weight: .05 lb./.02 kg.

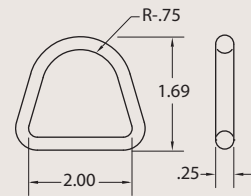

40025-12

2-inch D-Ring
WLL: 1,666 lbs./757 kg.
Weight: .09 lb./.04 kg.

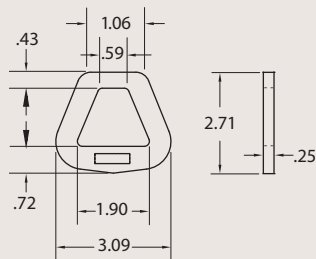

40978-11

2-inch Delta Ring
WLL: 3,333 lbs./1,515 kg.
Weight: .28 lb./.13 kg.

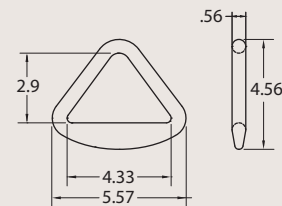

41631-12

4-inch Delta Ring
WLL: 6,666 lbs./3,030 kg.
Weight: 1.30 lbs./.59 kg.

PRODUCT FEATURES

- + ANCRAS RUST-RESISTANT, HIGH QUALITY ATTACHMENT HARDWARE IS MADE TO LAST.
- + OUR PRODUCTS AND COMPONENTS ARE FULLY TESTED TO MEET OUR EXACTING STANDARDS.

ATTACHMENT HARDWARE

BOLT PLATES

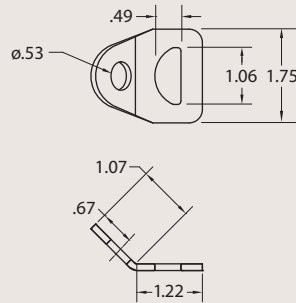

49917-10 1", 45 degree
Heat treated, Zinc Plated Gold Chromate Finish.
WLL: 1,000 lbs./450 kg.
Weight: .10 lbs./0.05 kg.

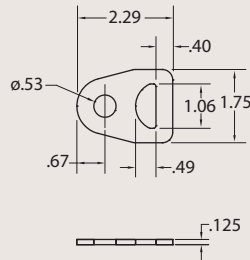

49917-11 1", Flat
Heat treated, Zinc Plated Gold Chromate Finish.
WLL: 1,000 lbs./450 kg.
Weight: .10 lbs./0.05 kg.

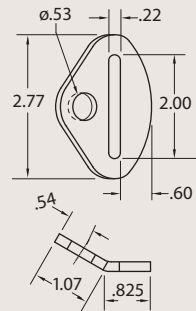

48904-10 2", 30 degree
Heat treated, Zinc Plated Clear Chromate Finish.
WLL: 1,000 lbs./450 kg.
Weight: .14 lbs./0.07 kg.

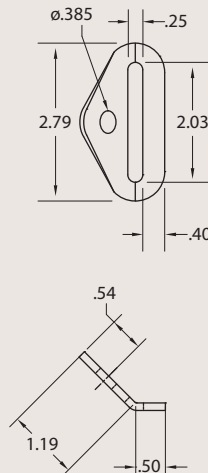
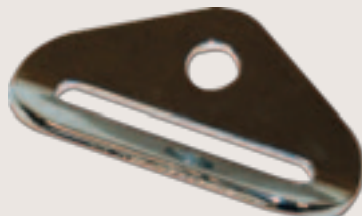

49968-10 2", 45 degree
Heat treated, Chrome Plated Finish.
WLL: 1,000 lbs./450 kg.
Weight: .10 lbs./0.05 kg.

OUR COMMITMENT TO
QUALITY IS NEVER ENDING



GENERAL HARDWARE & WEBBING

ATTACHMENT HARDWARE

Designed to fit securely into Ankra Track, sturdy Ankra Track Fittings are easy to use and long wearing.

TRACK FITTINGS

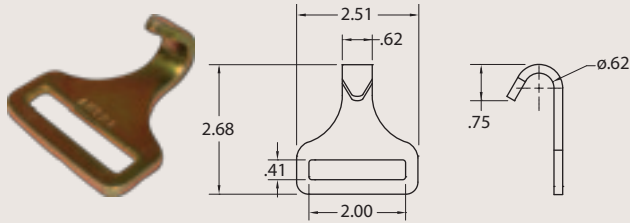

42012-12

Series F Heavy-Duty Track Hook
WLL: 800 lbs./363 kg.
Weight: .20 lb./.09 kg.

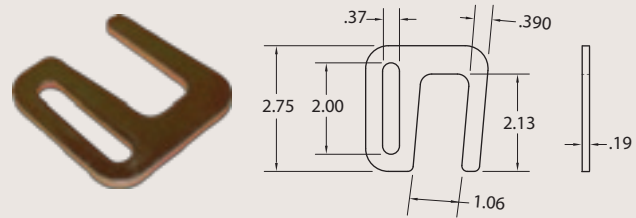

41325-10

Slat Hook. For use with Attachment Rails (Wooden Slats).
WLL: 1,000 lbs./454 kg.
Weight: .23 lb./.10 kg.

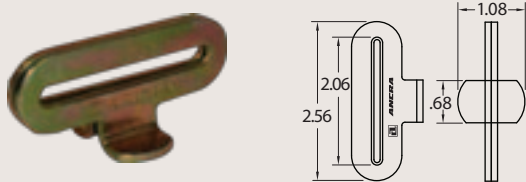

40980-11

Series F Track Fitting for 3/4" hole diameter (USA)
WLL: 500 lbs./225 kg.
Weight: .60 lb./.27 kg.

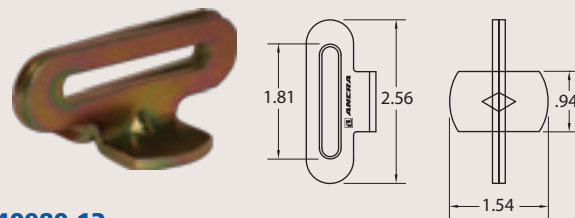

40980-13

For 1" hole diameter track (Canada)
WLL: 500 lbs./225 kg.
Weight: .60 lb./.27 kg.

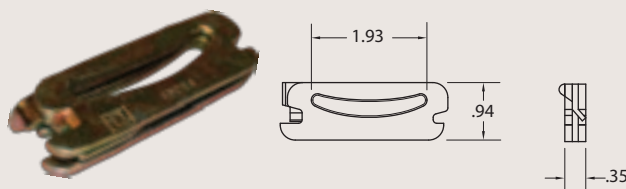

41409-13

Series E & A 3-Piece Track Fitting
WLL: 1,000 lbs./454 kg.
Weight: .20 lb./.09 kg.

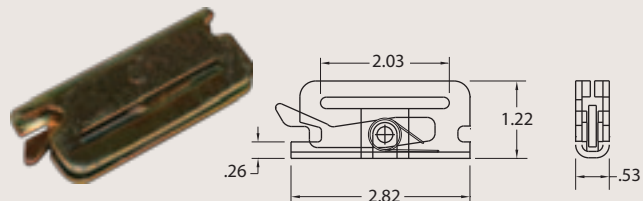

47608-21

Series E & A Track Spring Fitting
WLL: 1,333 lbs./605 kg. in 12-ga. track,
WLL: 1,500 lbs./680 kg. in 11-ga. track.
Weight: .22 lb./.10 kg.

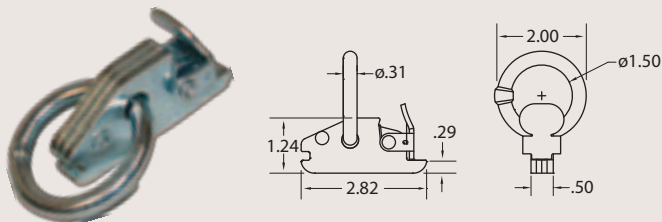

50115-10

Heavy-Duty Series E and A Track Fitting w/ Round Ring. Heat treated.
WLL: 2,000 lbs./900 kg.
Weight: .40 lbs./.18 kg.

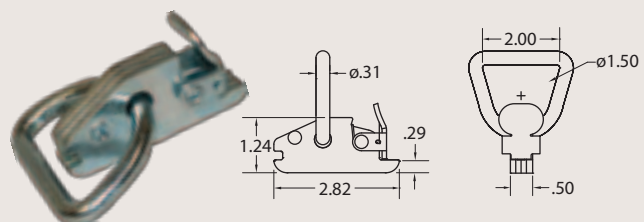

50115-11

Heavy-Duty Series E and A Track Fitting w/ D-Ring. Heat treated.
WLL: 2,000 lbs./900 kg.
Weight: .40 lbs./.18 kg.

ATTACHMENT HARDWARE

TRACK FITTINGS

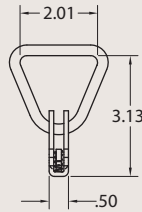
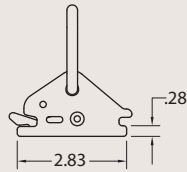

49542-10

Series E & A Fitting w/ D-Ring
WLL: 1,000 lbs./454 kg.
Weight: .32 lb./15 kg.

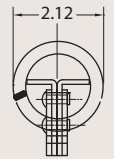
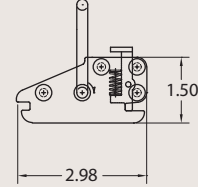

47772-12

Series E & A Track Fitting
WLL: 1,000 lbs./454 kg.
Weight: .45 lb./20 kg.

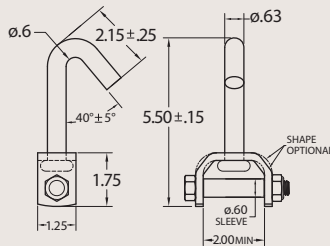

49914-10

Swivel J Idler Hook
Heat treated w/ gold zinc finish.
WLL: 3,333 lbs./1,515 kg.
Weight: 1.12 lbs./51 kg.

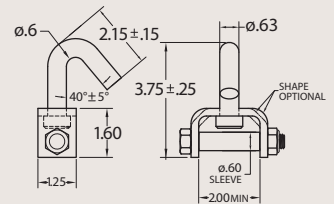

49914-11

Low Profile Swivel J Idler Hook
Heat treated w/ gold zinc finish
WLL: 3,333 lbs./1,515 kg.
Weight: .87 lb./40 kg.

CHAIN ATTACHMENTS

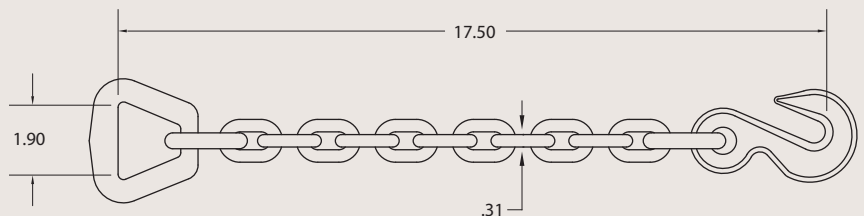

43366-21

Chain Anchor with Delta Ring for 2" Strap Assemblies. 5/16", G43 Chain and Grab Hook, gold zinc plated.
WLL: 3,330 lbs./1,510 kg.
Weight: 2.55 lbs./1.16 kg.

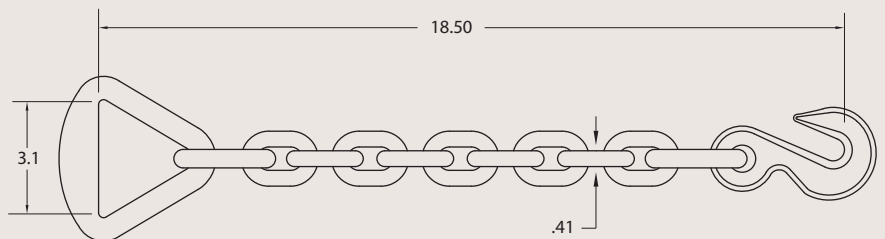

43366-14

Chain Anchor with Delta Ring for 3" & 4" Strap Assemblies. 3/8", G43 Chain and 3/8" G70 Grab Hook, gold zinc plated.
WLL: 5,400 lbs./2,450 kg.
Weight: 3.4 lbs./1.54 kg.

ATTACHMENT HARDWARE

Forged from high strength alloy steel, Ankra clevis hooks are made for Grade 70 chain. Sized from 1/4" to 1/2", the chain hooks are strength tested and heat treated for safety and durability. Meets Department of Transportation requirements.

Forged steel hook, Zinc Plated Gold Chromate finish. Individually polybagged.

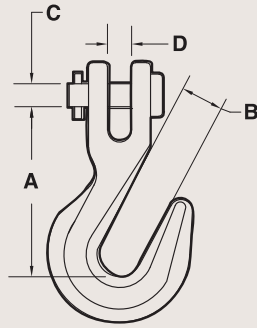

45946-12

1/4-in. Clevis Hook WLL: 3,150 lbs./1,430 kg.
Weight: .40 lbs./.18 kg.

45946-10

5/16-in. Clevis Hook WLL: 4,700 lbs./2,130 kg.
Weight: .85 lbs./.39 kg.

45946-11

3/8-in. Clevis Hook WLL: 6,600 lbs./2,990 kg.
Weight: 1.10 lbs./.5 kg.

45946-13

1/2-in. Clevis Hook WLL: 11,300 lbs./5,130 kg.
Weight: 2.10 lbs./1.04 kg.

DIMENSION TABLE

	A	B	C	D
45946-12	2.00	.40	.31	.36
45946-10	2.30	.43	.38	.38
45946-11	2.70	.50	.48	.44
45946-13	3.20	.66	.63	.75

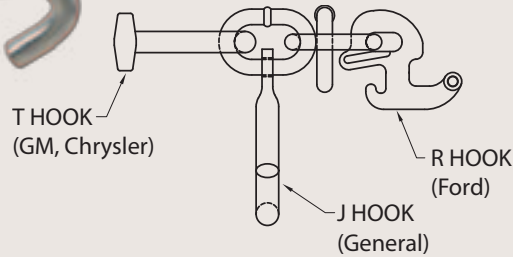

45515-10

RTJ Cluster Hook
WLL: 3,900 lbs./1,770 kg.
Weight: 2.65 lbs./1.20 kg.

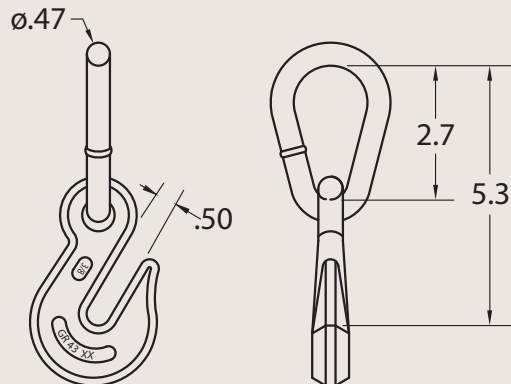

43365-12

Grab Hook Assembly
Heat Treated, Gold Zinc plated finish.
WLL: 5,400 lbs./2,450 kg.
Weight: 1.60 lbs./.73 kg.

CHAIN HARDWARE

We offer a wide selection of chain hardware for popular applications — from anchor shackles with screw pins and clevis pin models to Quick Links in various sizes. Corrosion resistant, gold zinc plated Grade 70 Twin Clevis and Slip Hooks come in a wide range of sizes, with and without safety latches. All are individually packaged.

Screw Pin Anchor Shackle — Galvanized and individually polybagged

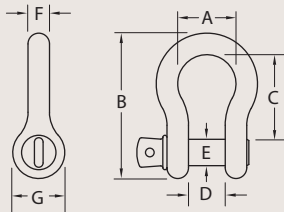

PART NUMBER	SIZE	WEIGHT	WLL				
50013-31	5/16-in.	.18 lbs./08 kg.	1,500 lbs./681 kg.				
50013-38	3/8-in.	.30 lbs./14 kg.	2,000 lbs./900 kg.				
50013-44	7/16-in.	.49 lbs./22 kg.	3,000 lbs./1,362 kg.				
50013-50	1/2-in.	.74 lbs./34 kg.	4,000 lbs./1,816 kg.				
50013-63	5/8-in.	1.44 lbs./65 kg.	6,500 lbs./2,951 kg.				
50013-75	3/4-in.	2.16 lbs./98 kg.	9,500 lbs./4,313 kg.				
50013-88	7/8-in.	3.37 lbs./1.52 kg.	13,000 lbs./5,896 kg.				
50013-100	1-in.	5.30 lbs./2.4 kg.	17,000 lbs./7,711 kg.				
	A	B	C	D	E	F	G
50013-31	.81	2.25	1.25	.53	Ø3/8	Ø.31	1.00
50013-38	.94	2.61	1.44	.66	Ø7/16	Ø.38	1.13
50013-44	1.06	3.01	1.69	.72	Ø1/2	Ø.44	1.25
50013-50	1.19	3.34	1.88	.81	Ø5/8	Ø.50	1.38
50013-63	1.50	4.04	2.41	1.06	Ø3/4	Ø.63	1.88
50013-75	1.75	5.04	2.84	1.25	Ø7/8	Ø.75	2.13
50013-88	2.00	5.86	3.31	1.44	Ø1.00	Ø.75	2.38
50013-100	2.31	6.63	3.75	1.69	Ø1.13	Ø.75	2.63

Clevis Pin Anchor Shackle — Galvanized and individually polybagged

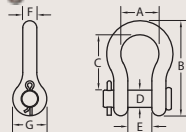

PART NUMBER	SIZE	WEIGHT	WLL				
50014-50	1/2-in.	.74 lbs./34 kg.	4,000 lbs./1,816 kg.				
50014-63	5/8-in.	1.44 lbs./65 kg.	6,500 lbs./2,951 kg.				
	A	B	C	D	E	F	G
50014-50	1.19	3.39	1.88	Ø5/8	.81	Ø.50	1.38
50014-63	1.50	4.17	2.41	Ø3/4	1.06	Ø.63	1.88

Quick Links — Zinc plated clear chromate and individually polybagged

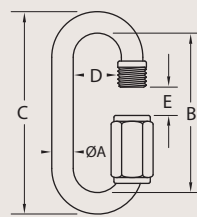

PART NUMBER	SIZE	WEIGHT	WLL				
50016-25	1/4-in.	.062 lbs./028 kg.	880 lbs./399 kg.				
50016-31	5/16-in.	.154 lbs./07 kg.	1,760 lbs./799 kg.				
50016-38	3/8-in.	.198 lbs./90kg.	2,200 lbs./998 kg.				
	A	B	C	D	E		
50016-25	.235	1.85	2.31	.51	.32		
50016-31	.313	2.32	2.95	.65	.41		
50016-38	.350	2.54	3.22	.67	.43		

GENERAL HARDWARE & WEBBING

CHAIN HARDWARE

Twin Clevis G70 — Forged steel with Zinc Plated Gold Chromate finish and individually polybagged.

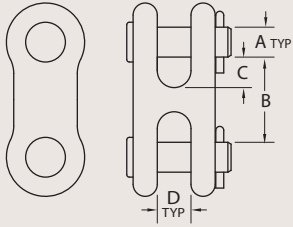

PART NUMBER	SIZE	WEIGHT	WLL	
50017-10	1/4-in. – 5/16-in.	.30 lbs./14 kg.	4,700 lbs./2,130 kg.	
50017-11	3/8-in.	.40 lbs./18 kg.	6,600 lbs./2,990 kg.	
50017-12	7/16-in – 1/2-in.	.98 lbs./44 kg.	11,300 lbs./5,130 kg.	
	A	B	C	D
50017-10	.38	1.18	.43	.47
50017-11	.47	1.34	.48	.53
50017-12	.56	1.75	.63	.65

Slip Hooks G70 without Safety Latch — Forged steel with Zinc Plated Gold Chromate finish and individually polybagged.

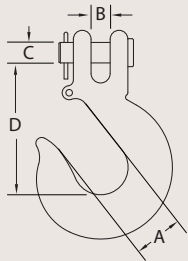

PART NUMBER	SIZE	WEIGHT	WLL	
50019-10	1/4-in.	.44 lbs./20 kg.	3,150 lbs./1,430 kg.	
50019-11	5/16-in.	.75 lbs./34 kg.	4,700 lbs./2,130 kg.	
50019-12	3/8-in.	1.13 lbs./51 kg.	6,600 lbs./2,990 kg.	
50019-13	1/2-in.	2.75 lbs./1.25 kg.	11,300 lbs./5,130 kg.	
	A	B	C	D
50019-10	.94	.44	.38	2.44
50019-11	1.06	.41	.44	2.72
50019-12	1.31	.59	.47	3.25
50019-13	1.75	.75	.63	4.00

Slip Hooks G70 with Safety Latch — Forged steel with Zinc Plated Gold Chromate finish and individually polybagged.

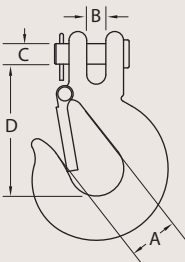

PART NUMBER	SIZE	WEIGHT	WLL	
50019-20	1/4-in.	.59 lbs./27 kg.	3,150 lbs./1,430 kg.	
50019-21	5/16-in.	.92 lbs./42 kg.	4,700 lbs./2,130 kg.	
50019-22	3/8-in.	1.32 lbs./60 kg.	6,600 lbs./2,990 kg.	
50019-23	1/2-in.	2.90 lbs./1.32 kg.	11,300 lbs./5,130 kg.	
	A	B	C	D
50019-20	.94	.44	.38	2.44
50019-21	1.06	.41	.44	2.72
50019-22	1.31	.59	.47	3.25
50019-23	1.75	.75	.63	4.00

WEBBING

Along with exceptional quality, Ancra's broad line of webbing gives you a range of choices to match your application. Custom made according to our strict specifications, Ancra webbing is treated for extra strength and durability, offering additional flexibility and ease of use.



Width in./mm.		Breaking Strength Capacity		Type	Standard Color	Part No.
in.	mm.	lbs.	kg.			
1.00	25	4,500	2,045	Nylon	■ Red ■ Blue ■ Black	41820-10-RL 41820-14-RL 41820-15-RL
2.00	50	6,000	2,727	Polyester	■ Yellow	47200-61-BULK-CUT
2.00	50	6,000	2,727	Polyester	■ Gray	47200-60-BULK-CUT
2.00	50	6,000	2,727	Polyester	■ Blue ■ Red	47200-62-BULK-CUT 47200-64-BULK-CUT
2.00	50	12,000	5,454	Polyester, Latex Treated	■ Blue ■ Yellow ■ Red	41632-26-BULK-CUT 41632-31-BULK-CUT 41632-19-BULK-CUT
3.00	75	18,000	8,181	Polyester, Latex Treated	■ Yellow ■ Blue	41632-17-BULK-CUT 41632-24-BULK-CUT
4.00	100	20,000	9,090	Polyester, Latex Treated	■ Gray ■ Blue ■ Red ■ Yellow ■ Green	43797-18-BULK-CUT 43797-19-BULK-CUT 43797-23-BULK-CUT 43797-36-RL 43797-34-BULK-CUT

Webbing will have a longer life if stored in a dry, dark location. Continuous exposure to ultra-violet light can degrade the strength of synthetic webbing.

WEBBING CHARACTERISTICS



Nylon's elongation characteristics make it suitable for slings and tow straps, but less desirable for heavy-duty tie downs. It displays good UV, abrasion, alkaline resistance and color fast properties. Polyester is well suited for webbing because of its low cost, high-strength, and resistance to abrasion. It also withstands acid environments and resists elongation in high moisture applications. Its durability and abrasion resistance can be increased even further with coatings of latex or other materials. Call Customer Service Department at 800-929-2627 for specific details and color availability.

SPECIALTY PRODUCTS

AIRCRAFT STYLE SEAT / LOGISTIC TRACK

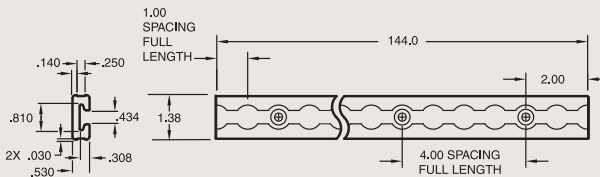
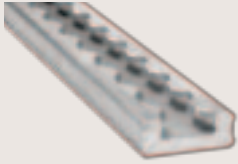

40467-33-144

12' long. Weight: 7.0 lbs./3.2 kg.

HEAVY-DUTY BEVELED AIRCRAFT STYLE TRACK

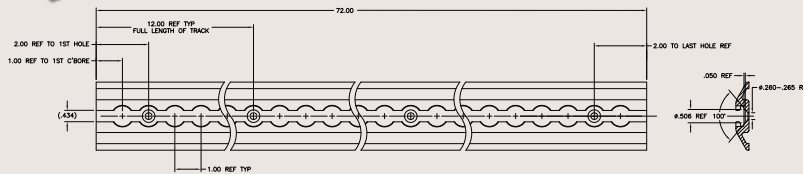

50193-30-72.00

72" long. Weight: 4.30 lbs./1.95 kg.

SINGLE STUD TRACK FITTING

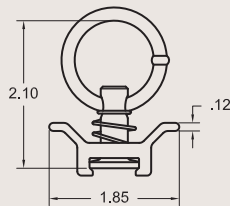

50112-10 Single Stud Track Fitting
Aluminum Retainer. WLL: 1,333 lbs./605 kg. Vertical.
Weight: .12 lb./.05 kg.

*Load rating varies with the angle of pull.

DOUBLE STUD TRACK FITTING WITH ROUND RING

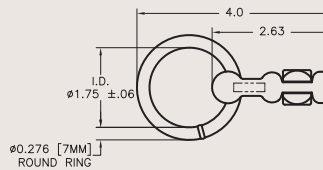

50362-11 Double Stud Track Fitting with Round Ring
WLL: 1,666 lbs./756 kg. Vertical.
Weight: .32 lb./.14 kg.

Dedicated to You

Ankra designs and manufactures a full spectrum of restraints and hardware to meet your wide ranging needs. Our specialty items represent our ongoing mission to provide the right solutions for a changing industry. If you can't find a specific product in this catalog, or if you have a particular requirement that calls for a unique solution, give us a call. Our customization capabilities can be your assurance that you have Ankra quality for all your cargo restraint applications.



SPECIALTY PRODUCTS

FORK LIFT STAND ALLOWS EASIER ACCESS FOR MAINTENANCE AND REPAIR

LR0401-01 Fork Lift Stand

Designed to comply with ASME PASE 2014 Standard for Portable Automotive Service Equipment, Ancra's American-made Fork Lift Stand offers a stable platform to raise your fork lift 20 inches for easier access from all sides.

Dimensions: 48" w x 20" h x 180" d
Weight: 1,260 lbs./571 kg.

- For lifts up to 10,000 lbs. with 62" maximum wheelbase and 30-40" track width
- 20,000 lbs. evenly distributed load capacity rating for properly installed assembly
- Includes removable approach ramps
- Protective lip lets operator know when to stop fork lift



SHOWCASE ANCRA PRODUCTS WITH CARGO CONTROL DISPLAYS

Display your cargo bars, beams, straps, coil racks and other Ancra products with display racks that break down and take less space in transportation and warehousing.

Available in two sizes — free standing and wall mounted, the secure displays come with hooks and offer flexibility in customizing your featured products.



50398-20

Cargo Control Display
Freestanding.

Dimensions: 24" x 20" x 71"

Weight: 100 lbs./45.5 kg.

28 Hooks provided.

Shipping size: 75" x 13" x 24"

GENERAL HARDWARE & WEBBING

MERCHANDISING AIDS

Contact our Customer Service Department to obtain.



Floor Stickers



Sold Here Sticker



Outdoor Banner

X-TREME_CC



Ergo_Bar_CC



Wall Chart



Goldline_CC



Product_CC



Catalog-220-LAM



Cargo Bar Display
49458-10



Part No.

Description

OUTDOOR_BANNER
SOLD_HERE_STICKER
FLOOR_STICKERS
CATALOG-220-LAM

OUTDOOR BANNER, 6' x 3' w/ 4 grommets
SOLD HERE WINDOW STICKER, 5" x 9-1/2"
TIE DOWN ZONE FLOOR GRAPHICS, 11" x 17"
CATALOG 220 LAMINATED

49458-10
WALL_CHART
ERGO_BAR_CC
X-TREME_CC

CARGO BAR DISPLAY
CARGO CONTROL WALL CHART - 18" x 24"
ERGO BAR COUNTER CARD, 8-1/2" x 11"
X-TREME PRODUCT COUNTER CARD, 8-1/2" x 11"

PRODUCT_CC
GOLDLINE_CC
LAD_TRAINING_DVD
LAD_SALES_DVD

CARGO CONTROL COUNTER CARD, 8-1/2" x 11"
GOLDLINE TARP TIES COUNTER CARD, 8-1/2" x 11"
LIFT A DECK II TRAINING VIDEO (DVD)
LIFT A DECK II SALES VIDEO (DVD)

GLIDELOCK_DVD

GLIDELOCK VIDEO (DVD)

Various Product Literature Available Upon Request

GENERAL INFORMATION

Ancra's cargo restraint products are backed by outstanding service:

Customer Assistance:

- Bar coding on standard products
- Technical training manuals
- CD ROM marketing material assistance
- Point of purchase selling aids

Engineering and Technical Services:

- Product development
- Design and drawing check – 3D solids
- Product testing and evaluation

Quality Assurance:

- Product inspection
- Vendor qualifications
- Internal and supplier audits
- Product and lot testing



SPECIFICATIONS

Working Load Limit (WLL)

The maximum load a component or assembly should be subjected to during routine use.

Rated Load Capacity

Ratings are generally established and/or regulated by industry or legislative standards and may vary from industry to industry. The working load limit rating (WLL) is established by Federal Motor Carriers Safety Administration standards at 1/3 of the Breaking Strength of the assembly.

Note: All strengths referenced in this brochure unless noted, are based on a straight pull application.

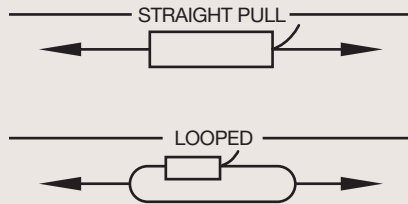

IMPORTANT NOTE:

It is the owner's and user's responsibility to determine suitability of a product for any particular use. Check all applicable industry, trade association, federal, state and local regulations. Read all operating instructions and warnings carefully.

All ratings shown in this catalog are based on the product being new, and used in normal environmental conditions. Special consideration must be given to item selection when unusual conditions can be expected. Particular caution should be exercised to avoid exposing the product to sharp edges, acids, alkalis and temperatures above 194°F.

Products are subjected to age, wear, and deterioration, all of which cause a reduction in the product's working load limit. We recommend that all products be regularly inspected. Any worn, deformed, misused or overloaded products should be replaced.

CAUTION! The component with the lowest working load capacity in the entire restraint system will determine its strength. Each component of the entire system plays an important part in restraining cargo. It is important that tie downs be attached to anchorage that are of sufficient strength to properly secure the load. For example, if one anchors a standard web binder assembly with a rated WLL of 5,000 lbs. to a device with a WLL of 1,000 lbs., then that system is only as good as the anchorage and would be limited to a 1,000 lbs. capacity WLL.

The purpose of this catalog is to assist our customers in the selection of cargo restraint products suitable for their specific applications. Because we continuously strive to offer new and improved products, part numbers and specifications are subject to change without notice. Please contact your Ancra Representative or our Customer Service Department for any new information.

WARRANTY

All Ancra Cargo products, unless otherwise indicated are warranted to be free from defect in material or workmanship for a period of six (6) months from date of shipment. During this period, Ancra Cargo will, at its option repair or replace without charge any products or part thereof found to be defective in material or workmanship. This warranty does not extend to any product which has been subject to misuse, abuse, negligence, accident, alteration or repair.

All Ancra Cargo SilverCap OverDrive product, unless otherwise indicated are warranted to be free from defect in material or workmanship for a period of twelve (12) months from date of shipment. During this period, Ancra Cargo will, at its option repair or replace without charge any product or part thereof found to be defective in material or workmanship. This warranty does not extend to any product which has been subject to misuse, abuse, negligence, accident, alteration or repair.

Ancra Cargo LAD II, RAR & or VAD systems, unless otherwise indicated are warranted to be free from defect in material or workmanship for a period of twenty-four (24) months from date of shipment. During this period, Ancra Cargo will, at its option repair or replace without charge any product or part thereof found to be defective in material or workmanship. This warranty does not extend to any product which has been subject to misuse, abuse, negligence, accident, alteration or repair.

Poly Deckboard and Ratchet Winches are warranted for a period of thirty-six (36) months from date of shipment. During this period, Ancra Cargo will, at its option repair or replace without charge any product or part thereof found to be defective in material or workmanship. This warranty does not extend to any product which has been subject to misuse, abuse, negligence, accident, alteration or repair.

Defective products must be returned to Ancra Cargo within the above period, transportation prepaid. Ancra will bear the cost of return transportation. Contact Customer Service for details.

THIS WARRANTY IS IN LIEU OF ALL OTHER WARRANTIES EXPRESSED OR IMPLIED INCLUDING BUT NOT LIMITED TO ANY IMPLIED WARRANTY OF MERCHANTABILITY OR FITNESS FOR ANY PARTICULAR PURPOSE. IN NO EVENT WILL ANCRACARGO BE LIABLE FOR SPECIAL, INDIRECT OR CONSEQUENTIAL DAMAGES OR LOSS OF VEHICLE, CARGO OR PROFITS.

INDUSTRY STANDARDS

Ancra has provided the following information as a service to our customers. This information is intended to promote the safe and informed sales and use of our products.

ALL CARGO RESTRAINTS, INCLUDING SYNTHETIC WEB TIE DOWNS SHALL BE USED IN ACCORDANCE WITH ALL STATE, FEDERAL, PROVINCIAL, LOCAL AND INDUSTRY REGULATIONS, AS APPLICABLE.

U.S. Department of Transportation regulations subchapter B-Motor Carrier Safety Regulations, 49 CFR, Part 393, Paragraph 393.102(b) requires that: "The aggregate working load limit of the tie down assemblies used to secure an article against movement in any direction must be at least 1/2 times the weight of that article."

It is the owner's and user's responsibility to determine suitability of a product for any particular use. All strap assemblies or systems are as strong as their weakest component, including the point of attachment.

An example using this regulation follows:

- Determine the number of synthetic web tie downs required when using the Working Load Limit (WLL) value marked on the synthetic web tie down assembly.
- Weight of article being secured is 24,000 LB (10,910 KG).
- Working Load Limit of the 3-inch synthetic web tie down is 4,000 LB (1,820 kg) as marked on the label.
- Required Aggregate WLL
 $1/2 \times 24,000 \text{ LB (Article Weight)} = 12,000 \text{ LB (5,455 KG)}$
- Minimum number of tie downs
 $12,000 \text{ LB} \div 4,000 \text{ LB (WLL of tie down)} = 3 \text{ tie downs}$

In this example, a minimum of 3 synthetic web tie downs are required to secure the article, based only on the weight of the article.

Some factors to be considered when determining the number and location of synthetic web tie downs, as specified by applicable regulations are:

- Article weight
- Configuration of load to be secured (pipe, coil, equipment, stacking, etc.)
- Number of tiers
- Length of load to be secured
- WLL of synthetic web tie downs
- Stakes, blocking and bracing
- Tension in the synthetic tie down shall never exceed the WLL strength rating of anchorage.
- Any other factors that may affect safe securement of the load during normal and emergency conditions.
- Also see Ancra tie down calculator APP — its free.

Operating Guidelines

This section provides recommended guidelines for the use, care, and inspection of synthetic web tie downs.

Use

- Inspect tie downs before each use, see Out-Of-Service Criteria.
- Synthetic web tie down assemblies shall not be loaded in excess of their Working Load Limit (WLL).

- Synthetic web tie downs shall be attached to provide control of load and positioned in accordance with applicable regulations.
- Synthetic web tie down assemblies shall not be dragged on floor, ground, or over an abrasive surface.
- Synthetic web tie downs shall not be tied in knots, or joined by knotting.
- Synthetic web tie downs shall not be pulled from under loads if the load is resting on the tie down.
- Synthetic web tie downs shall always be protected from being cut by sharp corners, sharp edges, protrusions or abrasive surfaces.
- The opening in fittings shall have the required shape and size to insure that the fitting will sit properly in the vehicle anchorage or other attachments. If the anchorage is inadequate to support the rating of the synthetic web tie down assembly, then the load rating will be limited to the strength of the anchorage.
- Synthetic web tie downs shall not be used for lifting or towing. This includes raising, lowering and suspending.
- Before operating any tie down assembly, the user shall secure his footing to prevent slipping or falling.
- In freezing temperatures caution shall be exercised when operating frozen tie down assemblies.
- A minimum of two (2) wraps of webbing shall be on the winch or ratchet buckle mandrel. Caution: Excessive wraps of webbing on the mandrel will reduce the working load limit of the winch or ratchet buckle.

When tightening or loosening winches, always maintain a firm grip on the winch bar. Never release a winch bar without checking the pawl to ensure that it is fully engaged between ratchet teeth. Releasing a winch bar without the pawl being properly engaged can cause serious injury to the user or bystanders. The use of a slip resistant handle winch bar specifically designed to tighten or loosen winches is recommended. Only winch bars designed to be used with winches shall be used to tension and release the tie down.

"Cheater Bars" ("extenders") shall not be used with winch bars.

The user shall stand clear (to one side) of the winch bar handle during operation, in case the winch bar slips. The tip of the winch bar shall be inserted through both holes in the end cap to prevent the winch bar from "slipping out" and overloading the tip and or end cap.

Synthetic web tie downs shall be used, checked and adjusted during the transportation of cargo per applicable federal, state, provincial, local and industry regulations.

Care

Environments in which synthetic web tie downs are continuously exposed to ultra-violet sunlight can affect the strength in varying degrees, ranging from slight to total degradation.

- Store in a clean, dry location out of direct sunlight.
- Avoid exposure to acids, alkalis or temperatures in excess of 194°F.

Inspection

Inspect equipment before each use. Do not use synthetic web tie downs that have excessive wear, cuts, abrasion or which have any other defect that should cause it to be pulled from service.

INDUSTRY STANDARDS

IT IS ULTIMATELY THE DRIVER'S RESPONSIBILITY TO INSURE THAT THE CARGO BEING HAULED IS PROPERLY SECURED. The U.S. Department of Transportation, Federal Motor Carrier Safety Administration regulation 49CFR Part 392.9(a) states: "A driver may not operate a commercial motor vehicle, and a motor carrier may not require or permit a driver to operate a commercial motor vehicle unless the commercial motor vehicle's cargo is properly distributed and adequately secured as specified in sections 393.100 through 393.142 of this subchapter." In addition, 49CFR Part 392.9(b) states: "Drivers of truck and truck tractors must assure himself/herself that the provisions of paragraph (a) of this section have been complied with before he/she drives that commercial motor vehicle; inspect the cargo and the devices used to secure the cargo within the first 50 miles after beginning a trip and cause any adjustments to be made to the cargo or load securement devices as necessary, including adding more securement devices, to ensure that cargo cannot shift on or within, or fall from the commercial motor vehicle; and reexamine the commercial motor vehicle's cargo and its load securement devices during the course of transportation and make any necessary adjustments to the cargo or load securement devices, including adding more securement devices, to ensure that the cargo cannot shift on or within, or fall from, the commercial motor vehicle."

The Federal Motor Carrier Safety Administration (FMCSA) has many useful guides to aid in understanding the cargo securement rules available at

www.fmcsa.dot.gov/regulations/cargo-securement/cargo-securement-rules

The Canadian Council of Motor Transport Administrators (CCMTA) has issued National Safety Code Standard 10 for Cargo Securement. They have copies of the regulation, training guides and driver handbooks available for purchase on their web site:

www.ccmta.ca/en/national-safety-code/nsc-cargo-securement-standards

Many states and provinces have their own unique requirements and it is again the driver's responsibility to make sure their load is secure and in compliance with local requirements.

CARE AND USE

INSPECT BEFORE USE – Do not use synthetic web tie downs if the webbing has excessive wear, is damaged, abraded or cut. Do not use if the hardware is damaged or defective. Do not use if there are knots in the webbing. Do not use if the WLL markings are not visible.

PROTECT FROM SHARP EDGES – Always use corner protectors or edge protectors to protect the straps when they are exposed to corners or abrasive or hot surfaces.

STORAGE – Store synthetic web tie downs in a clean dry place out of direct sunlight when not in use. Avoid exposure to acids, alkalis or temperatures in excess of 194 degrees F.

NOT FOR LIFTING OR TOWING – Do not use synthetic web tie down straps for lifting, lowering, suspending, recovery or towing. Use only properly marked and rated lifting slings for lifting, lowering or suspending applications and properly marked and rated recovery or tow straps for recovery or towing applications.

MODIFICATION OR MISUSE – Any modification or misuse of Ancra products will result in voiding of warranty and liability responsibility of Ancra Cargo.

WINCHES – Ancra cargo securement winches shall be installed, used and maintained in accordance with the information sheet provided with each winch. Ancra winches are designed to be used with Ancra winch bars inserted fully through the hole in the mandrel cap end. Do not use cheater bars or extenders on the Ancra winch bars.

WEBBING WRAPS – When using winch or ratchet straps, a minimum of two (2) and maximum of four (4) wraps of webbing shall be on the winch mandrel. Excessive wraps of webbing on the mandrel may reduce the working load limit (WLL) of the synthetic web tie down and may interfere with proper operation.

SECURE FOOTING – Before operating any synthetic web tie down assembly the user shall secure his footing to prevent slipping or falling. In adverse weather conditions, including freezing temperatures, additional caution should be exercised.

CAUTIONS AND WARNINGS – For the benefit of the user and the motoring public, each Ancra product is provided with instructions including cautions and warnings associated with its use. Failure to comply may result in personal injury, property damage or death.

RECOMMENDED OPERATING PRACTICES for SYNTHETIC WEB TIE DOWNS

These guidelines are not intended to replace proper training, experience and learned knowledge regarding proper tie down procedures.

SELECTION – Select a synthetic web tie down having suitable characteristics for the type of load, environment and attachment to vehicle anchor point. Fittings shall have the required shape and size to attach properly to the vehicle anchor points.

WORKING LOAD LIMIT – Identify the working load limit (WLL) marked on the synthetic web tie down by the manufacturer. If the required markings are illegible or missing, remove from service. Read all warnings and/or instructions provided by the manufacturer.

ANCHOR POINTS – Identify the working load limit (WLL) of the vehicle anchor points. If no rating is visible, contact the vehicle manufacturer for tie down instructions. The lesser-rated WLL, whether the anchor point or the synthetic web tie down, shall determine the WLL of the securement system.

NUMBER OF TIE DOWNS – Determine the proper number of synthetic web tie downs required based on the weight of the cargo, the type of commodity, the aggregate working load limit of the securement system and the length/weight ratio of the cargo being secured. Additionally, end users and enforcement personnel are required to know commodity-specific rules governing proper tie down determination as published by the Federal Motor Carrier Safety Administration Standard for Protection Against Shifting and Falling Cargo; Final Rule effective December 26, 2002.

OUT-OF-SERVICE CRITERIA (REPLACEMENT)

Synthetic web tie downs shall be removed from service if any of the following are visible:

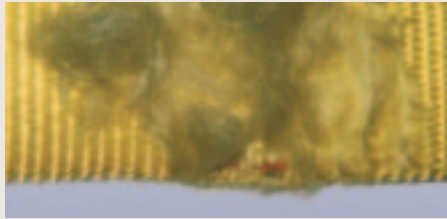

Excessive abrasive wear

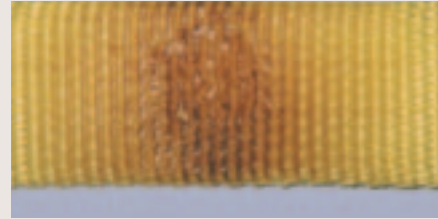

Melting or charring of the tie down, or weld splatter on the tie down

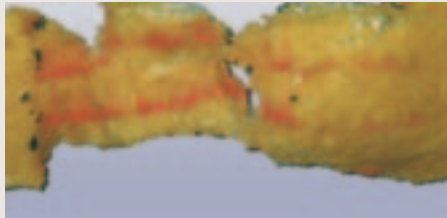

Chemical burns

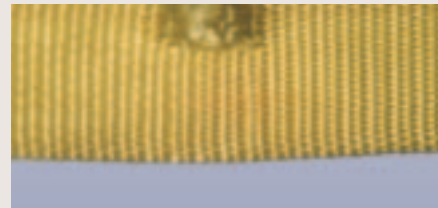

Holes, tears, cuts, snags



Tear in webbing or fitting

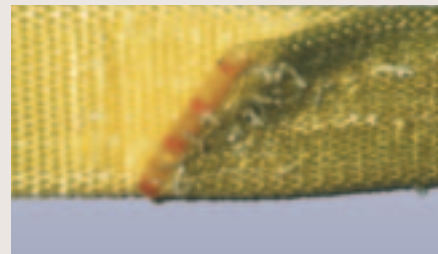

Broken or worn stitching in load bearing sew patterns

INFORMED SOURCES

U.S. Department of Transportation Federal Highway Administration (FHWA)
Website: www.fhwa.dot.gov

California Highway Patrol (CHP) Title 13
Website: www.chp.ca.gov

Web Sling & Tie Down Association (WSTDA)
Website: www.wstda.com

Specialized Carriers & Rigging Association (SC&RA)
Website: www.scranet.org

Truck Trailer Manufacturing Association (TTMA)
Website: www.ttmanet.org

Canada
The Ministry of Transportation in each Province
Website: www.mto.gov.on.ca

Mexico
Dir. General de Transporte Terrestre SubDirector de Inspeccion del Transporte

GLOSSARY

Abrasion	The mechanical wearing of a surface from contact with other object.
Aggregate Working Load Limit	The summation of the Working Load Limit (WLL) of all tie downs used to secure an article of cargo.
Anchor Point	The location to which a tie down is attached to a vehicle or article of cargo. If the anchor point is inadequate to support the force of the tie down system, then the load rating of the tie down will be limited to the strength of the anchor point.
Breaking Strength	The tensile load in pounds or kilograms at which any part of the securement assembly fails.
Cargo	All articles or material carried by a vehicle, including those used in operation of the vehicle.
Design Factor	The ratio of the breaking strength to the Working Load Limit (WLL).
Direct Tie Down	A tie down that is attached directly to the cargo.
Elongation	The measurement of stretch at a specifically applied load, expressed as a percentage of the original length.
Indirect Tie Down	A tie down which passes over the cargo and is secured to the vehicle at both ends. Tension in the tie down increases the pressure of an article or stack of articles on the deck of the vehicle.
Keeper	A device used on a hook to prevent the hook from inadvertently releasing.
Overall Length	The distance between extreme end bearing points of the synthetic web tie down assembly, including the fittings.
Lever Load Binder	A chain binder incorporating an overcenter locking action.
Proof Load Test	A non-destructive load test to some multiple of the working load limit.
Sew/Stitch Pattern	The pattern of the stitches used to sew the webbing together.
Shoring Bar	A structural bar placed transversely between the walls of a vehicle to prevent cargo from tipping or shifting.
Ultimate Test	A load test of a securement assembly tested to failure.
Winch	A device for tensioning a webbing or wire rope tie down that is fitted with means to lock the initial tension.
Working Load Limit (WLL)	The maximum load a component or assembly should be subjected to during routine use.

INNOVATIVE TEAMWORK SOLUTIONS

- ▶ **When we start a project with you, we develop shared objectives based on your specific goals.** We view your requirements from all angles. With over decades of industry experience, we don't automatically reach for the easy answers. The innovative solutions we've developed are a result of looking at each new project from a fresh perspective.
- ▶ We envision the global picture, and we sweat the details. Each part is tested and tested again against the highest standards of quality, reliability and durability.
- ▶ Through every step of the process, we work as a team with you. We continue to provide technical support after our products have been installed.

TRADE ASSOCIATIONS

	Web Sling & Tie Down Association (WSTDA)		Material Handling Industry (MHI)
	Air & Expedited Motor Carriers Assoc. (AEMCA)		Intermodal Association of North America (IANA)
	Technology & Maintenance Council (TMC)		National Trailer Dealers Association (NTDA)
	Truck Trailer Manufacturers Association (TTMA)		National Association of Trailer Manufacturers (NATM)
	Specialized Carriers & Rigging Association (SC&RA)		American Trucking Association (ATA)
	Commercial Vehicle Safety Network (CVSN)		National Private Truck Council (NPTC)
	Air Forwarders Association (AFA)		The Machinery Haulers Association (TMHA)

STATE TRUCKING ASSOCIATIONS

- ▶ Arkansas Trucking Association
- ▶ Alabama Trucking Association
- ▶ California Trucking Association
- ▶ Indiana Motor Truck Association
- ▶ Maine (Professional Logging Contractors)
- ▶ Minnesota Trucking Association
- ▶ Missouri Trucking Association
- ▶ New Jersey Motor Truck Association
- ▶ Ohio Trucking Association
- ▶ Pennsylvania Motor Truck Association
- ▶ Pennsylvania - Traffic Club of Philadelphia
- ▶ Texas Motor Transportation Association
- ▶ Tennessee Trucking Association
- ▶ Washington Trucking Association

LITERATURE AVAILABLE BY REQUEST



Engineered Products Brochure

Offers unique cargo transportation solutions that fit your own particular business model and will help you reach objectives that are critical to your success.

Request Brochure B-312



Ancra Cargo Cargo Restraint Catalog

Ancra showcases the most popular solutions for flatbed and interior van cargo restraints. A mini catalog of winches, straps, tie-offs, beams and bars.

Request Brochure 221



Ancra Cargo Lift-A-Deck II

Ancra's proprietary Lift-A-Deck decking systems enables optimum utilization of cargo space in vans and trailers.

Request Brochure B-254

GENERAL INFORMATION

INDEX BY PRODUCT NUMBER

10135	Overcenter Buckle - 2" - 3,000 lbs. WLL	90	20-EE1-9802X10	2" x 10' Eye/Eye 1 Ply Sling	81
10285-10	Releasable Trailer Door Strap	64	20-EE1-9802X12	2" x 12' Eye/Eye 1 Ply Sling	81
10632-90	2" x 18" Fixed End Strap w/ 44587-10 Buckle & 40891-18 Flat Hook	39	20-EE1-9802X14	2" x 14' Eye/Eye 1 Ply Sling	81
10632-90-28	2" x 28' Adjustable End Strap w/ 40891-18 Flat Hook	39	20-EE2-9801X4	1" x 4' Eye/Eye 2 Ply Sling	82
10632-93	2" x 33" Fixed End Strap w/ 44587-10 Buckle & 43366-21 Chain Anchor	39	20-EE2-9801X8	1" x 8' Eye/Eye 2 Ply Sling	82
10632-93-28	2" x 28' Adjustable End Strap w/ 43366-21 Chain Anchor	39	20-EE2-9802X3	2" x 3' Eye/Eye 2 Ply Sling	82
10632-95	2" x 18" Fixed End Strap w/ 44587-10 Buckle & 43120-13 Wire Hook	39	20-EE2-9802X4	2" x 4' Eye/Eye 2 Ply Sling	82
10632-95-28	2" x 28' Adjustable End Strap w /43120-13 Wire Hook	39	20-EE2-9802X6	2" x 6' Eye/Eye 2 Ply Sling	82
10633-90	3" x 18" Fixed End Strap w/ 48965-10 Buckle & 41766-18 Flat Hook	39	20-EE2-9802X8	2" x 8' Eye/Eye 2 Ply Sling	82
10633-90-28	3" x 28' Adjustable End Strap w/ 41766-18 Flat Hook	39	20-EE2-9802X10	2" x 10' Eye/Eye 2 Ply Sling	82
10633-92	3" x 33" Fixed End Strap w/ 48965-10 Buckle & 43366-14 Chain Anchor	39	20-EE2-9802X12	2" x 12' Eye/Eye 2 Ply Sling	82
10633-92-28	3" x 28' Adjustable End Strap w/ 43366-14 Chain Anchor	39	20-EE2-9802X16	2" x 16' Eye/Eye 2 Ply Sling	82
10634-90	4" x 18" Fixed End Strap w/ 49349-10 Buckle & 41766-18 Flat Hook	39	20-EE2-9802X20	2" x 20' Eye/Eye 2 Ply Sling	82
10634-90-28	4" x 28' Adjustable End Strap w/ 41766-18 Flat Hook	39	20-EE2-9802X30	2" x 30' Eye/Eye 2 Ply Sling	82
10634-91	4" x 33" Fixed End Strap w/ 49349-10 Buckle & 43366-14 Chain Anchor	39	20-EE2-9803X10	3" x 10' Eye/Eye 2 Ply Sling	82
10634-91-28	4" x 28' Adjustable End Strap w/ 43366-14 Chain Anchor	39	20-EE2-9803X12	3" x 12' Eye/Eye 2 Ply Sling	82
10634-93	4" x 20" Fixed End Strap w/ 49349-10 Buckle & 43120-20 Wire Hook	39	20-EE2-9803X16	3" x 16' Eye/Eye 2 Ply Sling	82
10634-93-28	4" x 28' Adjustable End Strap w/ 43120-20 Wire Hook	39	20-EE2-9803X20	3" x 20' Eye/Eye 2 Ply Sling	82
10788-10	Door Pull Strap	63	20-EE2-9804X6	4" x 6' Eye/Eye 2 Ply Sling	82
10865-11	100" Wide x 90.5" Tall Cargo Net	69	20-EE2-9804X8	4" x 8' Eye/Eye 2 Ply Sling	82
10924-10	Trailer Door Limit Strap	65	20-EE2-9804X10	4" x 10' Eye/Eye 2 Ply Sling	82
10902-11PK	Driver Assist Strap, Single Loop	65	20-EE2-9804X12	4" x 12' Eye/Eye 2 Ply Sling	82
10902-21	Driver Assist Strap, Dual Loop	65	20-EE2-9804X16	4" x 16' Eye/Eye 2 Ply Sling	82
10939-10	Gear Drive Tensioner Snap Hook	40	20-EE2-9804X20	4" x 20' Eye/Eye 2 Ply Sling	82
10939-12	Gear Drive Tensioner Flat Hook	40	20-ENR1X3	1" x 3' Purple Endless Round Sling	80
20-EE1-9801X3	1" x 3' Eye/Eye 1 Ply Sling	81	20-ENR1X4	1" x 4' Purple Endless Round Sling	80
20-EE1-9801X4	1" x 4' Eye/Eye 1 Ply Sling	81	20-ENR1X6	1" x 6' Purple Endless Round Sling	80
20-EE1-9801X6	1" x 6' Eye/Eye 1 Ply Sling	81	20-ENR1X8	1" x 8' Purple Endless Round Sling	80
20-EE1-9801X10	1" x 10' Eye/Eye 1 Ply Sling	81	20-ENR1X12	1" x 12' Purple Endless Round Sling	80
20-EE1-9802X3	2" x 3' Eye/Eye 1 Ply Sling	81	20-ENR2X3	2" x 3' Green Endless Round Sling	80
20-EE1-9802X4	2" x 4' Eye/Eye 1 Ply Sling	81	20-ENR2X4	2" x 4' Green Endless Round Sling	80
20-EE1-9802X6	2" x 6' Eye/Eye 1 Ply Sling	81	20-ENR2X8	2" x 8' Green Endless Round Sling	80
			20-ENR2X12	2" x 12' Green Endless Round Sling	80
			20-ENR2X20	2" x 20' Green Endless Round Sling	80
			20-ENR3X3	3" x 3' Yellow Endless Round Sling	80
			20-ENR3X4	3" x 4' Yellow Endless Round Sling	80
			20-ENR3X8	3" x 8' Yellow Endless Round Sling	80
			20-ENR3X12	3" x 12' Yellow Endless Round Sling	80
			20-ENR3X20	3" x 20' Yellow Endless Round Sling	80
			20-ENR4X10	4" x 10' Tan Endless Round Sling	80
			20-ENR4X16	4" x 16' Tan Endless Round Sling	80
			20-ENR5X4	5" x 5' Red Endless Round Sling	80
			20-ENR5X6	5" x 6' Red Endless Round Sling	80
			20-ENR5X12	5" x 12' Red Endless Round Sling	80
			20-ENR5X20	5" x 20' Red Endless Round Sling	80
			20-ENR7X6	7" x 7' Blue Endless Round Sling	80
			30A533-BK	2" x 33" Black Axle Strap w/ Sleeve	77
			30ATB	Adjustable Tire Bonnet	78

INDEX BY PRODUCT NUMBER

30RT	Double Adjustable Tire Bonnet	78	40758-11	Snap Hook, Twisted - 2" - 3,333 lbs. WLL	94
310R-120	Galvanized Steel Tether Track	58	40758-13	Snap Hook - 2" - 3,333 lbs. WLL	94
40023-12	Wire Hook, Wide - 2" - 833 lbs. WLL	92	40838-10	Series E Vertical Track (Gray) 10'	56
40024-10	Wire Hook, Narrow - 1" - 1,000 lbs. WLL	92	40838-11	Series E Vertical Track (Galvanized) 10'	56
40024-12	Wire Hook, Narrow - 2" - 833 lbs. WLL	92	40849-12	Series F Track (Galvanized) 10', 1" Holes Canada	57
40025-10	D-Ring - 1" - 1,666 lbs. WLL	94	40849-14	Series F Track (Galvanized) 10', 1.62" Hole Spacing	57
40025-12	D-Ring - 2" - 1,666 lbs. WLL	94	40880-15	Cam Buckle - 2" - 833 lbs. WLL Replaces 40880-19	91
40044-10	Flat Hook w/ Keeper - 1" - 1,166 lbs. WLL	93	40880-22	Cam Buckle - 1" - 600 lbs. WLL	91
40065-10	Flat Hook - 1" - 333 lbs. WLL	93	40891-18	Flat Hook - 2" - 3,333 lbs. WLL	93
40065-12	Flat Hook, Vinyl - 1" - 333 lbs. WLL	93	40921-10	Beam Socket	60
40084-14	Snap Hook - 2" - 2,100 lbs. WLL	93	40921-11	Beam Socket Heavy-Duty	60
40316-12	Wire Hook, Narrow - 1" - 166 lbs. WLL	92	40978-11	Delta Ring - 2" - 3,333 lbs. WLL	94
40340-27	Single Stud Track Fitting - 1,333 lbs. Vertical WLL	102	40980-11	Track Fitting Series F - 500 lbs. WLL	96
40386-10	Rope Tie Off - Series E (3 piece End Fitting) 1,000 lbs. WLL	63	40980-13	Track Fitting Series F - 500 lbs. WLL (Canada)	96
40386-11	Rope Tie Off - Series E (Spring Actuated Fitting) 1,333 lbs. WLL	63	40985-05-12	Web Protector - Cordura Sleeve - 12" Long	17
40386-12	Rope Tie Off - Series F - 500 lbs. WLL	63	40985-05-RL	Web Protector - Cordura Sleeve - 100 Yd. Roll	17
40386-13	Rope Tie Off - Series F - 500 lbs. WLL (Canada)	63	41030-12	Cam Buckle - 1" - 166 lbs. WLL Replaces 41030-10	91
40467-33-144	Heavy-Duty Aircraft Track 12'	102	41048-10	Ancra Red Motorcycle Strap - 1" x 5.5'	82
40602-10	Series E Strap Assy - 3-pc. End - 12'	67	41048-23	Ancra Red Motorcycle Strap - 1" x 13'	82
40602-11	Series E Strap Assy - 3-pc. End - 16'	67	41313-12	S Hook, Plated - 1" - 400 lbs. WLL	92
40602-12	Series E Strap Assy - 3-pc. End - 20'	67	41313-13	S Hook, Vinyl - 1" - 400 lbs. WLL	92
40602-17	Series E Strap Assy - 1-pc. End - 12'	67	41313-19	S Hook, Vinyl - 1" - 600 lbs. WLL	92
40602-18	Series E Strap Assy - 1-pc. End - 16'	67	41325-10	Slat Hook - 1,000 lbs. WLL	96
40602-19	Series E Strap Assy - 1-pc. End - 20'	67	41409-13	Series E End Fitting (3 Piece) 1,000 lbs. WLL	96
40602-20	Series F Strap Assembly - Cam Buckle - 12'	67	41631-12	Delta Ring - 4" - 6,666 lbs. WLL	94
40602-21	Series F Strap Assembly - Cam Buckle - 16'	67	41632-17-BULK-CUT	3" Yellow Polyester Latex Treated Webbing	101
40602-22	Series F Strap Assembly - Cam Buckle - 20'	67	41632-19-BULK-CUT	2" Red Polyester Latex Treated Webbing	101
40602-97	Plate Trailer Strap Assembly w/ Wire Hooks - Cam Buckle - 12'	68	41632-24-BULK-CUT	3" Blue Polyester Latex Treated Webbing	101
40602-98	Plate Trailer Strap Assembly w/ Wire Hooks - Cam Buckle - 16'	68	41632-26-BULK-CUT	2" Blue Polyester Lated Treated Webbing	101
40602-99	Plate Trailer Strap Assembly w/ Wire Hooks - Cam Buckle - 20'	68	41632-31-BULK-CUT	2" Yellow Polyester Latex Treated Webbing	101
40602-100	LAD II Logistics Strap w/ Single Stud Fitting - Cam Buckle - 12'	51	41645-10	Roller Buckle - 2" - 500 lbs. WLL	91
40602-101	LAD II Logistics Strap w/ Single Stud Fitting - Cam Buckle - 16'	51	41659-10-27	2" x 27' Winch Strap w/ 40891-18 Flat Hook	31
40602-102	LAD II Logistics Strap w/ Single Stud Fitting - Cam Buckle - 20'	51	41659-10-30	2" x 30' Winch Strap w/ 40891-18 Flat Hook	31
40602-103	Series F Strap Assembly - Cam Buckle - 12' - Canada	67	41659-11-27	2" x 27' Winch Strap w/ 40978-11 Delta Ring	31
40602-104	Series F Strap Assembly - Cam Buckle - 16' - Canada	67	41659-11-30	2" x 30' Winch Strap w/ 40978-11 Delta Ring	31
40602-105	Series F Strap Assembly - Cam Buckle - 20' - Canada	67	41659-13-27	2" x 27' Winch Strap w/ 43120-13 Wire Hook	31
			41659-13-30	2" x 30' Winch Strap w/ 43120-13 Wire Hook	31
			41659-15-27	2" x 27' Winch Strap w/ 43366-21 Chain Anchor	31
			41659-15-30	2" x 30' Winch Strap w/ 43366-21 Chain Anchor	31
			41659-16-30	2" x 30' Winch Strap w/o Hardware	31
			41659-90-27	2" x 27' ANCRA X-TREME Winch Strap w/ 40891-18 Flat Hook	28

GENERAL INFORMATION

INDEX BY PRODUCT NUMBER

41659-90-30	2" x 30' ANCRA X-TREME Winch Strap w/ 40891-18 Flat Hook	28	43099-10	Flat Hook - 2" - 1,666 lbs. WLL	93
41659-92-30	2" x 30' ANCRA X-TREME Winch Strap w/ 43120-13 Wire Hook	28	43120-11	Wire Hook, Narrow - 2" - 1,666 lbs. WLL	92
41659-93-30	2" x 30' ANCRA X-TREME Winch Strap w/ 43366-21 Chain Anchor	28	43120-13	Wire Hook, Narrow - 2" - 3,333 lbs. WLL	92
41659-94-30	2" x 30' ANCRA X-TREME Winch Strap w/o Hardware	28	43120-19	Wire Hook, Narrow - 1.75" - 500 lbs. WLL	92
41660-10-27	3" x 27' Winch Strap w/ 41766-18 Flat Hook	32	43120-20	Wire Hook, Narrow - 3" - 7,333 lbs. WLL	92
41660-10-30	3" x 30' Winch Strap w/ 41766-18 Flat Hook	32	43320-32	Ratchet Buckle - 1" - 1,466 lbs. WLL	88
41660-14-27	3" x 27' Winch Strap w/ 43366-14 Chain Anchor	32	43365-12	Grab Hook Assembly, Unplated - 5,400 lbs. WLL	98
41660-14-30	3" x 30' Winch Strap w/ 43366-14 Chain Anchor	32	43366-14	Chain Anchor w/ Delta Ring - 5,400 lbs. WLL	97
41660-17-30	3" x 30' Winch Strap w/o Hardware	32	43366-21	5/16" Chain Anchor w/ Delta Ring - 3,333 lbs. WLL	97
41660-18-27	3" x 27' Winch Strap w/ 43120-20 Wire Hook	32	43488-20	Combo Winch - Side Mount - Low Profile	7
41660-18-30	3" x 30' Winch Strap w/ 43120-20 Wire Hook	32	43546-10	Gutter Hook - 1" - 250 lbs. WLL	93
41660-90-30	3" x 30' ANCRA X-TREME Winch Strap w/ 41766-18 Flat Hook	29	43563-10	Web Winch - Bottom Mount - Std.	2
41660-93-30	3" x 30' ANCRA X-TREME Winch Strap w/ 43366-14 Chain Anchors	29	43563-10-RW	Web Winch - Bottom Mount - Std. Weld-on	2
41660-95-30	3" x 30' ANCRA X-TREME Winch Strap w/o Hardware	29	43564-12	Web Winch - Bottom Mount - Std. Storable Portable w/ 2SS.	2
41681-10	Combo Winch - Bottom Mount - Std.	7	43564-147	Web Winch - Bottom Mount - Std. Portable w/ 2SS w/ 7mm Frame	2
41691-10	Web Winch - Frameless	3	43564-167	Web Winch - Side Mount - Low Profile Portable w/ 2SS.	2
41696-10	Cable Winch - End Mount - RH	7	43565-127	Web Winch - Bottom Mount - Storable C Track Slider w/ 7mm Frame	3
41696-11	Cable Winch - End Mount - LH	7	43565-127-RW	Web Winch - Bottom Mount - Storable Web C Track Slider	3
41766-18	Flat Hook - 3" - 5,400 lbs. WLL	93	43565-127-XZ	Web Winch - Bottom Mount - Deep Storable C Track Slider - X-Treme Zinc Finish	3
41766-19	Flat Hook - 3" - 5,400 lbs. WLL w/ Keeper	93	43565-137	Web Winch - Bottom Mount - C Track Slider - Double Cap w/ 7mm Frame	3
41808-14	Ratchet Buckle - 1 3/4" - 2,000 lbs. WLL	88	43565-14	Web Winch - Bottom Mount - Storable C Track Slider w/ 7mm Frame	3
41820-10-RL	1" Red Nylon Webbing	101	43565-157	Web Winch - Bottom Mount - Std. C Track Slider w/ 7mm Frame	4
41820-14-RL	1" Blue Nylon Webbing	101	43565-157-RW	Web Winch - Bottom Mount - Std. C Track Slider Ratcheting	4
41820-15-RL	1" Black Nylon Webbing	101	43565-157-XZ	Web Winch - Bottom Mount - Std. C Track Slider - X-Treme Zinc Finish	4
42012-12 HD	Series F Hook - 800 lbs. WLL	96	43573-10	Web Winch - Bottom Mount - Std. Storable	2
42098-11	Corner Protector - 3" - Rubber	17	43579-20	Web Winch - Side Mount - Low Profile	3
42098-12	Corner Protector - 4" - Rubber	17	43627-13	Replacement Channel Assembly (Al. Beam)	60
42195-11	Cam Buckle - 1" - 500 lbs. WLL Replaces 42195-10.	91	43638-50	Decking/Shoring Beam Series E - 85.7" - 96.6" Long	59
42313-10	Winch Bar - Std. Painted	14	43638-51	Decking/Shoring Beam Series E - 91.9" - 102.9" Long	59
42313-12	Winch Bar - Combination Box End Painted Silver & Yellow	14	43781-145	Long Foot Assembly (2 x 4)	61
42313-17	Winch Bar - Std. Chrome	14	43781-155	Short Foot Assembly (2 x 4)	61
42313-19	Winch Bar - Combination Chrome	14	43781-16	Long Foot Assembly (4 x 4)	61
42357-11	Winch Track - 6' Steel.	11	43781-17	Short Foot Assembly (4 x 4)	61
42357-12	Winch Track - 12' Steel.	11			
42357-21	Winch Track - 6' Aluminum	11			
42816-18	Overcenter Buckle - 1" - 600 lbs. WLL	90			
42948-10	Series A Horizontal Track (Gray) 10'	56			
43044-10	Snap Hook - 1" - 1,666 lbs. WLL	94			

INDEX BY PRODUCT NUMBER

43782-15	Cargo Sta - Standard - 89.75" to 104.5" Long . . . 61	43797-34-BULK-CUT	4" Green Polyester Latex Treated Webbing 101
43795-10-27	4" x 27' Winch Strap w/ 41766-18 Flat Hook 32	43797-36-RL	4" Yellow Polyester Latex Treated Webbing 101
43795-10-30	4" x 30' Winch Strap w/ 41766-18 Flat Hook 32	43887-10	Mini Ratchet Strap - 1" x 16" - Display Packaged . . . 84
43795-10-35	4" x 35' Winch Strap w/ 41766-18 Flat Hook 32	43887-11	Mini Ratchet Strap - 1" x 20" - Display Packaged . . . 84
43795-10-40	4" x 40' Winch Strap w/ 41766-18 Flat Hook 32	43887-15	Mini Ratchet Strap - 1" x 9" - Display Packaged . . . 84
43795-10-50	4" x 50' Winch Strap w/ 41766-18 Flat Hook 32	43986-10	Corner Protector - 4" - Black Plastic 17
43795-11-27	4" x 27' Winch Strap w/ 41631-12 Delta Ring . . . 32	43997-10	Combo Winch - Leg Mount - Low Profile 7
43795-11-30	4" x 30' Winch Strap w/ 41631-12 Delta Ring . . . 32	44102-11	H-2 Hook 15
43795-11-35	4" x 35' Winch Strap w/ 41631-12 Delta Ring . . . 32	44122-10	Corner Iron Hook 15
43795-11-40	4" x 40' Winch Strap w/ 41631-12 Delta Ring . . . 32	44232-10	Ratchet Buckle - 1" - 400 lbs. WLL 88
43795-11-50	4" x 50' Winch Strap w/ 41631-12 Delta Ring . . . 32	44258-13	Ratchet Buckle - 2" - 1,500 lbs. WLL - Low Profile . . 89
43795-13-30	4" x 30' Winch Strap w/ Half Twisted Loop 32	44340-11	Strap Assy - 1" - Ratchet Buckle - 10' w/ Wire Hooks 84
43795-13-45	4" x 45' Winch Strap w/ Half Twisted Loop 32	44557-10	Ancra Lash R/B Strap - 1" x 15" - Bulk - 400 lbs. WLL . . 84
43795-13-50	4" x 50' Winch Strap w/ Half Twisted Loop 32	44587-10	Ratchet Buckle - 2" - 3,666 lbs. WLL - Long Wide Handle 89
43795-13-65	4" x 65' Winch Strap w/ Half Twisted Loop 32	44627-11	Ratchet Buckle - 2" - 3,333 lbs. WLL - Standard Handle 89
43795-13-75	4" x 75' Winch Strap w/ Half Twisted Loop 32	45143-20	Basket Strap for Tires 7" W x 20" H 77
43795-14-27	4" x 27' Winch Strap w/ 43365-12 Grab Hook . . . 32	45143-22	Basket Strap for Tires 8" W x 24" H 77
43795-14-30	4" x 30' Winch Strap w/ 43365-12 Grab Hook . . . 32	45228-10	Rave Hook - 1,167 lbs. WLL 92
43795-15-27	4" x 27' Winch Strap w/ 43366-14 Chain Anchor 33	45515-10	Cluster Hook (RTJ) 98
43795-15-30	4" x 30' Winch Strap w/ 43366-14 Chain Anchor 33	45545-15	Pan Fitting w/ Black Trim Collar 64
43795-19-30	4" x 30' Winch Strap w/o Hardware 33	45801-10	Web Winder 15
43795-40-30	4" x 30' Winch Strap w/ 41766-18 Flat Hook - Blue Webbing 33	45849-15	Recessed Pan Fitting 1,666 lbs. WLL 64
43795-60-30	4" x 30' Winch Strap w/ 41766-18 Flat Hook - Red Webbing 33	45880-10	G70 Chain - 5/16" Bulk 4,700 lbs. WLL 400' Barrel 21
43795-90-27	4" x 27' ANCRA X-TREME Winch Strap w/ 41766-18 Flat Hook 30	45880-11	G70 Chain - 3/8" Bulk 6,600 lbs. WLL 200' Barrel 21
43795-90-30	4" x 30' ANCRA X-TREME Winch Strap w/ 41766-18 Flat Hook 30	45880-12	G70 Chain - 1/4" Bulk 3,150 lbs. WLL 400' Barrel 21
43795-90-40	4" x 40' ANCRA X-TREME Winch Strap w/ 41766-18 Flat Hook 30	45880-13	G70 Chain - 1/2" Bulk 11,300 lbs. WLL 100' Barrel . . 21
43795-91-27	4" x 27' ANCRA X-TREME Winch Strap w/ 41631-12 Delta Ring 30	45881-10-16	G70 Chain Assy - 5/16" x 16" w/ Clevis Hooks 4,700 lbs. WLL 21
43795-91-30	4" x 30' ANCRA X-TREME Winch Strap w/ 41631-12 Delta Ring 30	45881-10-16-SP	G70 Chain Assy - 5/16" x 16" w/ Clevis Hooks 4,700 lbs. WLL - In Pail 22
43795-91-40	4" x 40' ANCRA X-TREME Winch Strap w/ 41631-12 Delta Ring 30	45881-10-20	G70 Chain Assy - 5/16" x 20" w/ Clevis Hooks 4,700 lbs. WLL 21
43795-92-30	4" x 30' ANCRA X-TREME Winch Strap w/o Hardware 30	45881-10-20-SP	G70 Chain Assy - 5/16" x 20" w/ Clevis Hooks 4,700 lbs. WLL - In Pail 22
43795-93-30	4" x 30' ANCRA X-TREME Winch Strap w/ Half Twist 30	45881-10-25	G70 Chain Assy - 5/16" x 25" w/ Clevis Hooks 4,700 lbs. WLL 21
43795-95-30	4" x 30' ANCRA X-TREME Winch Strap w/ 43366-14 Chain Anchor 30	45881-10-25-SP	G70 Chain Assy - 5/16" x 25" w/ Clevis Hooks 4,700 lbs. WLL - In Pail 22
43797-18-BULK-CUT	4" Gray Polyester Latex Treated Webbing 101	45881-11-16	G70 Chain Assy - 3/8" x 16" w/ Clevis Hooks 6,600 lbs. WLL 21
43797-19-BULK-CUT	4" Blue Polyester Latex Treated Webbing 101	45881-11-16-SP	G70 Chain Assy - 3/8" x 16" w/ Clevis Hooks 6,600 lbs. WLL - In Pail 22
43797-23-BULK-CUT	4" Red Polyester Latex Treated Webbing 101		

GENERAL INFORMATION

INDEX BY PRODUCT NUMBER

45881-11-20	G70 Chain Assy - 3/8" x 20' w/ Clevis Hooks 6,600 lbs. WLL	19	45982-36	2" x 30' Ratchet Strap w/ 40758-11 Snap Hooks	36
45881-11-20-SP	G70 Chain Assy - 3/8" x 20' w/ Clevis Hooks 6,600 lbs. WLL - In Pail	20	45982-42	2" x 27' Ratchet Strap w/ 43120-13 Wire Hooks	36
45881-11-25	G70 Chain Assy - 3/8" x 25' w/ Clevis Hooks 6,600 lbs. WLL	21	45982-43	2" x 30' Ratchet Strap w/ 43120-13 Wire Hooks	34
45881-11-25-SP	G70 Chain Assy - 3/8" x 25' w/ Clevis Hooks 6,600 lbs. WLL - In Pail	22	45982-43-30-WK	2" x 30' Ratchet Strap w/ 43120-13 Wire Hooks, w/ Web Keeper Buckle	38
45881-13-20	G70 Chain Assy - 1/2" x 20' w/ Clevis Hooks 11,300 lbs. WLL	21	45982-90-27	2" x 27' Ratchet Strap w/ 40891-18 Flat Hooks	32
45881-13-25	G70 Chain Assy - 1/2" x 25' w/ Clevis Hooks 11,300 lbs. WLL	21	45982-90-27-WK	2" x 27' Ratchet Strap w/ 40891-18 Flat Hooks, w/ Web Keeper Buckle	38
45943-10	Chain Load Binder - 5/16" Lever 5,400 lbs. WLL	26	45982-90-30	2" x 30' Ratchet Strap w/ 40891-18 Flat Hooks	34
45943-10-HD	Chain Load Binder, Heavy-Duty - 5/16" Lever 5,400 lbs. WLL	26	45982-90-30-WK	2" x 30' Ratchet Strap w/ 40891-18 Flat Hooks, w/ Web Keeper Buckle	38
45943-11	Chain Load Binder - 3/8" Lever 9,200 lbs. WLL	26	45982-93-30	2" x 30' Ratchet Strap w/ 43366-21 Chain Anchors	34
45943-12	Chain Load Binder - 1/4" Lever 2,500 lbs. WLL	26	45982-95-27	2" x 27' Ratchet Strap w/ 43120-13 Wire Hooks	34
45943-13	Chain Load Binder - 1/2" Lever 13,000 lbs. WLL	26	45982-95-27-WK	2" x 27' Ratchet Strap w/ 43120-13 Wire Hooks, w/ Web Keeper Buckle	38
45943-14	Recoilless Chain Load Binder - 5/16" Lever 5,400 lbs. WLL	26	45982-95-30	2" x 30' Ratchet Strap w/ 43120-13 Wire Hooks	34
45943-20	Chain Load Binder - 5/16" Ratchet 5,400 lbs. WLL	27	45982-95-30-WK	2" x 30' Ratchet Strap w/ 43120-13 Wire Hooks, w/ Web Keeper Buckle	38
45943-20-HD	Chain Load Binder, Heavy-Duty - 5/16" Ratchet 5,400 lbs. WLL	27	45988-15	Mini Ratchet Strap	84
45943-21	Chain Load Binder - 3/8" Ratchet 9,200 lbs. WLL	27	46006-11	Series E & A Track End Caps	57
45943-23	Chain Load Binder - 1/2" Ratchet 13,000 lbs. WLL	27	47105-11	Ratchet Buckle - 2" - 3,666 lbs. WLL - Short Wide Handle	89
45946-10	5/16" Clevis Hook 4,700 lbs. WLL	23, 98	47200-60-BULK-CUT	2" Gray Polyester Webbing	101
45946-11	3/8" Clevis Hook 6,600 lbs. WLL	23, 98	47200-61-BULK-CUT	2" Yellow Polyester Webbing	101
45946-12	1/4" Clevis Hook 3,150 lbs. WLL	23, 98	47200-62-BULK-CUT	2" Blue Polyester Webbing	101
45946-13	1/2 in. Clevis Hook 11,300 lbs. WLL	23, 98	47200-64-BULK-CUT	2" Red Polyester Webbing	101
45951-12	Flat Latch Repair Kit	60	47235-10	Series F Channel - 10' (1" Hole Spacing)	58
45982-10	2" x 27' Ratchet Strap w/ 40891-18 Flat Hooks	36	47556-11	Double Stud Fitting - 1,666 lbs. WLL	102
45982-11	2" x 30' Ratchet Strap w/ 40891-18 Flat Hooks	36	47608-21	Series E Track Fitting - 1,333 lbs. WLL	96
45982-11-30-WK	2" x 30' Ratchet Strap w/ 40891-18 Flat Hooks, w/ Web Keeper Buckle	38	47640-31	Lashing Winch - 3,333 lbs. w/ Double Hex Drive	8, 78
45982-15	2" x 27' Ratchet Strap w/ 43366-21 Chain Anchors	36	47670-10	Hoop Set - Decking Beam	59
45982-19	2" x 27' Ratchet Strap w/ 40758-11 Snap Hooks	36	47772-12	Series E Track Fitting w/ Round Ring - 1,000 lbs. WLL	63, 97
45982-34	2" x 30' Ratchet Strap w/ 43366-21 Chain Anchors	36	47800-10	Overcenter Buckle - 1 3/4" - 1,666 lbs. WLL	90
			47934-11	Wheel Dolly Strap 2" x 86"	77
			47935-11	Wheel Dolly Strap w/ S Hooks	77
			47935-12	Wheel Dolly Strap w/ Spring E Fittings	77
			47944-10	Round Ring - 2" - 900 lbs. WLL	94
			47970-10	2" x 27' Ratchet Strap w/ 40891-18 Flat Hooks	36

INDEX BY PRODUCT NUMBER

47970-11	2" x 30' Ratchet Strap w/ 40891-18 Flat Hooks . . . 36	48672-24	Plate Trailer Ratchet Strap Assy w/ Wire Hooks 20' 69
47971-10	2" x 27' Ratchet Strap w/ 40891-18 Flat Hooks . . . 36	48672-33	Series E TLR Ratchet Strap - 1-pc. End - 12' 66
47971-11	2" x 30' Ratchet Strap w/ 40891-18 Flat Hooks . . . 36	48672-34	Series E TLR Ratchet Strap - 1-pc. End - 16' 66
48101-103	Web Winch - 3-Bar - Weld-on 6	48672-35	Series E TLR Ratchet Strap - 1-pc. End - 20' 66
48101-143	Web Winch - 3-Bar - Standard 6	48770-10	Ratchet Buckle - 1" - 500 lbs. WLL 88
48101-173	Web Winch - 3-Bar - Standard C Track Slider 6	48904-10	Bolt Plate, 2", 30 degree, Clear Zinc Plated 95
48117-21-120.00	Series E Horizontal Track - 10' (Galvanized) 56	48922-10	2 x 18" Fixed End Strap w/ 40891-18 Flat Hook & Loop 39
48117-21-60.00	Series E Horizontal Track - 5' (Galvanized) 56	48922-11	3 x 18" Fixed End Strap w/ 41766-18 Flat Hook & Loop 40
48117-25-120.00	Series E Horizontal Track - 10' (Gray) 56	48922-12	4 x 18" Strap w/ 41766-18 Flat Hook & Loop 40
48117-25-60.00	Series E Horizontal Track - 5' (Gray) 56	48922-13	2 x 18" Fixed End Strap w/ 43120-13 Wire Hook & Loop 39
48117-32-120.00	Series E Horizontal Track - 10' Black Powdercoat . . 56	48922-15	4 x 18" Strap w/ 43120-20 Narrow Hook & Loop 40
48253-13	Plate Trailer Ratchet Strap w/ Wire Hook and E Fitting 12' 69	48922-16	2" Fixed End Strap w/ 43366-21 Chain Anchor & Loop 39
48253-14	Plate Trailer Ratchet Strap w/ Wire Hook and E Fitting 16' 69	48922-17	3 x 33" Strap w/ 43366-12 Chain Anchor & Loop 40
48253-15	Plate Trailer Ratchet Strap w/ Wire Hook and E Fitting 20' 69	48922-18	4 x 33" Strap w/ 43366-14 Chain Anchor & Loop 40
48253-16	Plate Trailer Ratchet Strap w/ F Fitting and E Fitting 12' 69	48922-20	3 x 18" Strap w/ 43365-12 Grab Hook & Loop 40
48253-17	Plate Trailer Ratchet Strap w/ F Fitting and E Fitting 16' 69	48965-10	Ratchet Buckle - 3" - 7,333 lbs. WLL 90
48253-18	Plate Trailer Ratchet Strap w/ F Fitting and E Fitting 20' 69	48968-11	Roll-Off Container Hook - 5,400 lbs. WLL 93
48253-19	Plate Trailer Cam Strap w/ Wire Hook and E Fitting 12' 68	48987-20	3" x 27' Ratchet Strap w/ 41766-18 Flat Hooks - 5,400 lbs. WLL 37
48253-20	Plate Trailer Cam Strap w/ Wire Hook and E Fitting 16' 68	48987-21	3" x 30' Ratchet Strap w/ 41766-18 Flat Hooks - 5,400 lbs. WLL 37
48253-21	Plate Trailer Cam Strap w/ Wire Hook and E Fitting 20' 68	48987-24	3" x 27' Ratchet Strap w/ 43366-12 Chain Anchors - 5,400 lbs. WLL 37
48253-22	Plate Trailer Cam Strap w/ F Fitting and E Fitting 12' 68	48987-25	3" x 30' Ratchet Strap w/ 43366-12 Chain Anchors - 5,400 lbs. WLL 37
48253-23	Plate Trailer Cam Strap w/ F Fitting and E Fitting 16' 68	48987-28	3" x 27' Ratchet Strap w/ 43120-20 Wire Hooks - 5,400 lbs. WLL 37
48253-24	Plate Trailer Cam Strap w/ F Fitting and E Fitting 20' 68	48987-29	3" x 30' Ratchet Strap w/ 43120-20 Wire Hooks - 5,400 lbs. WLL 37
48407-10	Economy Cargo Sta 87" - 102" - Square Feet 61	48987-90-27	3" x 27' ANCRA X-TREME Ratchet Strap w/ 41766-18 Flat Hooks 34
48485-11	Single Replacement Cleat 76	48987-90-30	3" x 30' ANCRA X-TREME Ratchet Strap w/ 41766-18 Flat Hooks 34
48487-24	2" x 140" Auto Hauler Winch Strap 76	48987-92-27	3" x 27' ANCRA X-TREME Ratchet Strap w/ 43366-14 Chain Anchors 34
48672-13	Series E Ratchet Strap - 1-pc. End - 12' 69	48987-92-30	3" x 30' ANCRA X-TREME Ratchet Strap w/ 43366-14 Chain Anchors 34
48672-14	Series E Ratchet Strap - 1-pc. End - 16' 69	49015-18	18" Door Pull Strap 63
48672-15	Series E Ratchet Strap - 1-pc. End - 20' 69		
48672-16	LAD Ratchet Strap w/ Double Stud Fitting 12' 51		
48672-17	LAD Ratchet Strap w/ Double Stud Fitting 16' 51		
48672-18	LAD Ratchet Strap w/ Double Stud Fitting 20' 51		
48672-22	Plate Trailer Ratchet Strap Assy w/ Wire Hooks 12' 69		
48672-23	Plate Trailer Ratchet Strap Assy w/ Wire Hooks 16' 69		

GENERAL INFORMATION

INDEX BY PRODUCT NUMBER

49015-24	24" Door Pull Strap	63	49313-13	Series L Track (Galvanized) 10', 1" Notched Holes	57
49015-36	36" Door Pull Strap	63	49344-10	Coil Rack - Light Duty	16
49020-20	6' Auto Tie Down Strap w/ Snap Hooks	76	49344-12	Coil Rack - Heavy-Duty	16
49020-21	8' Auto Tie Down Strap w/ Snap Hooks	76	49345-10	Floor Chain Tie Down - Welded	27
49020-22	12' Auto Tie Down Strap w/ Snap Hooks	76	49346-10	4" x 27' Ratchet Strap w/ 41766-18 Flat Hooks - 5,400 lbs. WLL	37
49021-20	Series E HD Ratchet Buckle Strap - 12'	69	49346-11	4" x 30' Ratchet Strap w/ 41766-18 Flat Hooks - 5,400 lbs. WLL	37
49021-21	Series E HD Ratchet Buckle Strap - 16'	69	49346-12	4" x 27' Ratchet Strap w/ Narrow Wire Hooks - 6,600 lbs. WLL	37
49021-22	Series E HD Ratchet Buckle Strap - 20'	69	49346-13	4" x 30' Ratchet Strap w/ Narrow Wire Hooks - 6,600 lbs. WLL	37
49021-30	Series E HD TLR Ratchet Buckle Strap - 12'	66	49346-14	4" x 27' Ratchet Strap w/ 43366-14 Chain Anchor - 5,400 lbs. WLL	37
49021-31	Series E HD TLR Ratchet Buckle Strap - 16'	66	49346-15	4" x 30' Ratchet Strap w/ 43366-14 Chain Anchor - 5,400 lbs. WLL	37
49021-32	Series E HD TLR Ratchet Buckle Strap - 20'	66	49346-90-27	4" x 27' Ratchet Strap w/ 41766-18 Flat Hooks	35
49023-20	Auto Tie Down - Series E w/ RTJ Hooks - 6'	77	49346-90-30	4" x 30' Ratchet Strap w/ 41766-18 Flat Hooks	35
49023-21	Auto Tie Down - Series E w/ RTJ Hooks - 8'	77	49346-91-27	4" x 27' Ratchet Strap w/ 43366-14 Chain Anchors	35
49023-22	Auto Tie Down - Series E w/ RTJ Hooks - 12'	77	49346-91-30	4" x 30' Ratchet Strap w/ 43366-14 Chain Anchors	35
49025-20	Electronic Strap 12'	67	49346-93-27	4" x 27' Ratchet Strap w/ 43120-13 Wire Hooks	35
49025-21	Electronic Strap 16'	67	49346-93-30	4" x 30' Ratchet Strap w/ 43120-13 Wire Hooks	35
49025-22	Electronic Strap 20'	67	49347-10	2" x 18" Fixed End Strap w/ 40891-18 Flat Hook & Ratchet	39
49039-50	HD Series E Beam Assy - 96"	59	49347-11	2" x 25' Strap w/ 40891-10 Flat Hook	39
49039-51	HD Series E Beam Assy - 102"	59	49347-12	2" x 28' Strap w/ 40891-10 Flat Hook	39
49039-52	HD Series E Beam Assy - 106"	59	49347-13	3" x 18" Strap w/ 41766-18 Flat Hook & Ratchet	40
49205-25	Heavy-Duty Jack Bar One-Piece - Galvanized - Bolt-on Feet - 85" - 104"	62	49347-14	3" x 25' Strap w/ 41766-18 Flat Hook - 15,000 lbs.	40
49205-26	Heavy-Duty Jack Bar One-Piece - Galvanized - Bolt-on Feet - 85" - 114"	62	49347-15	3" x 28' Strap w/ 41766-18 Flat Hook - 15,000 lbs.	40
49205-27	Heavy-Duty Jack Bar One-Piece Galvanized w/ Hoop Bolt-on Feet 85" - 114"	62	49347-16	4" x 18" Strap w/ 41766-18 Flat Hook & Ratchet	40
49205-31	Universal Jack Bar 51" to 114"	62	49347-17	4" x 25' Strap w/ 41766-18 Flat Hook - 15,000 lbs.	40
49207-127	Winch Double L Slider Storable - w/ 7mm Frame	4	49347-18	4" x 28' Strap w/ 41766-18 Flat Hook - 15,000 lbs.	40
49207-127-XZ	Winch Double L Slider Storable - w/ 7mm Frame X-Treme Zinc Plated	4	49347-19	2" x 18" Fixed End Strap w/ 43120-13 Wire Hook & Buckle	39
49207-137	Winch Double L Slider Standard - w/ 7mm Frame	4	49347-20	2" x 25' Adjustable End w/ 43120-13 Wire Hook	39
49207-137-RW	Winch Double L Slider Standard	4	49347-21	2" x 28' Adjustable End w/ 43120-13 Wire Hook	39
49207-137-XZ	Winch Double L Slider Standard - w/ 7mm Frame X-Treme Zinc Plated	4			
49207-187	Winch Double L Slider Low Profile w/ 7mm Frame	5			
49207-187-RW	Winch Double L Slider Low Profile	5			
49207-187-XZ	Winch Double L Slider Low Profile w/ 7mm Frame X-Treme Zinc Plated	5			
49207-273	3-Bar Standard Double L Slider Winch	6			
49207-273-XZ	3-Bar Standard Double L Slider Winch X-Treme Zinc Finish	6			
49207-283-XZ	3-Bar Low Profile Double L Slider Winch X-Treme Zinc Finish	6			
49211-10	Rubber Rope Hooks - 100-pc. Bag	19			
49242-10-120	Winch Track - 10' Aluminum Double L	11			
49246-10-BP	Winch Std Utility Trailer Track Slider w/ Clip	5			

INDEX BY PRODUCT NUMBER

49347-25	4" x 18" Strap w/ 43120-20 Narrow Hook & Buckle	40	49446-10	Lift-A-Deck Kit with Beam Release Bar	48
49347-26	4" x 25' Strap w/ 43120-20 Narrow Hook	40	49454-11	Rubber Rope - 3/8" Solid Core - 150' Roll	20
49347-27	4" x 28' Strap w/ 43120-20 Narrow Hook	40	49454-13	Rubber Rope - 7/16" Solid Core - 150' Roll	20
49347-28	2" x 33" Fixed End Strap w/ 43366-21 Chain Anchor & Ratchet	39	49526-10	4" x 5' Strap w/ Hook for Roll-Off Containers	33
49347-29	2" x 25' Strap w/ 43366-21 Chain Anchor	39	49526-11	4" x 5' Strap w/ Sewn Loop End for Roll-Off Containers	33
49347-30	2" x 28' Strap w/ 43366-21 Chain Anchor	39	49526-90	4" x 5' ANCRA X-TREME Strap w/ Hook for Roll-Off Containers	33
49347-31	3" x 33" Strap w/ 43366-12 Chain Anchor & Buckle	40	49526-91	4" x 5' ANCRA X-TREME Strap w/ Sewn Loop for Roll-Off Containers	33
49347-32	3" x 25' Strap w/ 43366-12 Chain Anchor	40	49527-10	GlideLock Slider Bracket - For Double L Track	16
49347-33	3" x 28' Strap w/ 43366-12 Chain Anchor	40	49542-10	E Fitting w/ D-Ring	63, 97
49347-34	4" x 33" Strap w/ 43366-14 Chain Anchor & Buckle	40	49562-17-72.00	LAD Narrow Single Track	50
49347-35	4" x 25' Strap w/ 43366-14 Chain Anchor	40	49577-10	Chain Corner Protector	17
49347-36	4" x 28' Strap w/ 43366-14 Chain Anchor	40	49583-10	Floor Chain Tie Down - Bolt-on	27
49347-40	3" x 18" Strap w/ 43365-12 Grab Hook & Buckle	40	49584-10	Plastic Corner Protector	17
49347-41	3" x 25' Strap w/ 43365-12 Grab Hook	40	49706-10	Winch Standard Wilson Track Slider w/ Clip	5
49347-42	3" x 28' Strap w/ 43365-12 Grab Hook	40	49715-10	Ratchet Buckle - 2" - 1,500 lbs. WLL - TLR	89
49348-11	Bar Keep Cargo Bar Holder	63	49716-10	Porta Winch	9
49349-10	Ratchet Buckle - 4" - 8,000 lbs. WLL	90	49716-10-RW	Ratcheting Porta Winch	9
49359-10	Series A Horizontal Track Aluminum	56	49716-11	Porta Winch Offset	9
49360-13	Decking/Shoring Beam Steel Series E - 92.1" - 102.9" Long	59	49717-10	Porta Anchor	9
49368-10	Strap Assy - 1" - Ratchet Buckle - 15' w/ Vinyl S Hooks, 4-pack	84	49723-10	Silvercap Overdrive Ratcheting Cap	12
49371-10	Stake Pocket Anchor	64	49756-10	Steel Corner Protector	17
49377-10	Corner Protector - Steel for Chain	17	49768-10	Sliding Double L Hook	15
49377-11	Rubber Coated Steel Corner Protector	17	49770-10	Waste Container J Hook - 5,100 lbs. WLL	93
49384-12	Steel Beam Track Stop	48	49789-10-120.00	Winch Track - 10' Aluminum Double L Low Profile	11
49400-10	Jack Bar Component Kit - Red Handle	61	49811-20L	Low Profile Foot and Channel Assembly	46
49410-13	Ratchet Buckle - 2" - 3,666 lbs. WLL - TLR	89	49828-10-30	1/4" x 30' Cable Assembly w/ Chain Anchor	41
49414-15	LAD Beam Standard - 95.1" - 105.6"	47	49828-10-32	1/4" x 32' Cable Assembly w/ Chain Anchor	41
49414-15-RT	Replacement Tube for 49414-15 Standard LAD Beam	48	49828-11-30	5/16" x 30' Cable Assembly w/ Chain Anchor	41
49414-19	LAD Beam Heavy-Duty - 95.2 - 105.6	47	49828-11-32	5/16" x 32' Cable Assembly w/ Chain Anchor	41
49414-19-RT	Replacement Tube for 49414-19 Heavy-Duty LAD Beam	48	49828-12-30	7/32" x 30' Cable Assembly w/ Chain Anchor	41
49414-21	Aftermarket Beam Standard - 97.3" - 108.8"	49	49828-12-32	7/32" x 32' Cable Assembly w/ Chain Anchor	41
49414-21-RT	Replacement Tube for 49414-21	49	49834-10	3 Bar Adjuster - 2" - 1,000 lbs. WLL	91
49439-10	Shoring Bar, F Series - Round	60	49893-10	18" x 18" Safety Flag & Wooden Dowel	72
49439-11	Shoring Bar, F Series - Round (1" Hole Track)	60	49893-11	18" x 18" Cotton Flag w/ Steel Rod	72
49439-20	Shoring Bar, F Series - Square	60	49893-12	18" x 18" Red Flag w/ Grommets	72
49439-21	Shoring Bar, F Series - Square (1" Hole Track)	60	49893-13	18" x 18" PVC Coated Orange Flag & Wooden Dowel	72
49443-10	Housing Assembly (w/ Trigger, Set Screw, Rack & Lever)	61	49893-14	18" x 18" PVC Coated Orange Flag w/ Grommets	72
49445-12	Beam Release Bar	48	49893-18	18" x 18" Fluorescent Orange Mesh Flag w/ Wire Hooks	72
			49894-10	18" x 84" Wide Oversized Load Banner w/ 4 Ropes	73
			49894-11	18" x 84" Wide Oversized Load Banner w/ 2 Ropes	73

GENERAL INFORMATION

INDEX BY PRODUCT NUMBER

49894-12	14" x 72" Wide Oversized Load Banner w/ 4 Ropes	73	50016-31	Quick Links - Zinc Plated, 5/16", 1,760 lbs. WLL	24, 99
49894-13	18" x 84" Oversized Load Mesh Banner	73	50016-38	Quick Links - Zinc Plated, 3/8", 2,200 lbs. WLL	24, 99
49894-14	18" x 84" Wide Load Mesh Banner	73	50017-10	Twin Clevis G70 - Zinc Plated, 5/16", 4,700 lbs. WLL	25, 100
49895-10	12" x 96" Canadian D Sign w/ 8 Grommets	73	50017-11	Twin Clevis G70 - Zinc Plated, 3/8", 6,600 lbs. WLL	25, 100
49895-11	12" x 96" Reflective Canadian D Sign w/ 10 Grommets	73	50017-12	Twin Clevis G70 - Zinc Plated, 7/16", 11,300 lbs. WLL	25, 100
49895-12	18" x 96" Reflective Canadian D Sign w/ 10 Grommets	73	50019-10	Slip Hooks G70 - Zinc Plated - No Latch, 1/4", 3,150 lbs. WLL	25, 100
49895-13	18" x 96" Reflective Canadian D Sign w/ 10 Grommets, reverse side: Oversize Load	73	50019-11	Slip Hooks G70 - Zinc Plated - No Latch, 5/16", 4,700 lbs. WLL	25, 100
49896-10	1/2" Forged Ring Assy w/ Bolt-on Clip	14	50019-12	Slip Hooks G70 - Zinc Plated - No Latch, 3/8", 6,600 lbs. WLL	25, 100
49896-11	1/2" Forged Ring Assy w/ Weld-on Clip	14	50019-13	Slip Hooks G70 - Zinc Plated - No Latch, 1/2", 11,300 lbs. WLL	25, 100
49897-10	5/8" Forged Ring Assy w/ Weld-on Clip	14	50019-20	Slip Hooks G70 - Zinc Plated - w/ Safety Latch, 1/4", 3,150 lbs. WLL	25, 100
49898-10	3/4" Forged Ring Assy w/ Weld-on Clip	14	50019-21	Slip Hooks G70 - Zinc Plated - w/ Safety Latch, 5/16", 4,700 lbs. WLL	25, 100
49899-10	1" Forged Ring Assy w/ Weld-on Clip	14	50019-22	Slip Hooks G70 - Zinc Plated - w/ Safety Latch, 3/8", 6,600 lbs. WLL	25, 100
49913-10	Tarp Protector	17	50019-23	Slip Hooks G70 - Zinc Plated - w/ Safety Latch, 1/2", 11,300 lbs. WLL	25, 100
49914-10	Swivel J Idler Fitting - 3,333 lbs. WLL	97	50024-10	Tarp Hook	15
49914-11	Swivel J Idler Fitting Low Profile - 3,333 lbs. WLL	97	50037-10	Ratchet Buckle - 2" - 3,666 lbs. WLL - Web Keeper LWH	89
49917-10	Bolt Plate, 1" 45 degree	95	50055-10	Beam Release Bar Holder	47
49917-11	Bolt Plate, 1" Flat	95	50058-18-72.00	LAD Flanged Single Track	50
49968-10	Bolt Plate, 2" 45 degree	95	50072-14-72.00	LAD Flanged Double Track	51
49988-10	Pallet Deck	54	50080-11	Wide Top LAD Beam Assembly - 95.1" - 105.6"	47
49997-113	Web Winch - Side Mount - 3-Bar	6	50080-11-RT	Replacement Tube for 50080-11	48
50013-31	Screw Pin Anchor Shackle - Galvanized, 5/16", 1,500 lbs. WLL	24, 99	50089-12	X-TREME Corner Guards - 12" x 8" x 8" - Made In The USA	18
50013-38	Screw Pin Anchor Shackle - Galvanized, 3/8", 2,000 lbs. WLL	24, 99	50089-24	X-TREME Corner Guards - 24" x 8" x 8" - Made In The USA	18
50013-44	Screw Pin Anchor Shackle - Galvanized, 7/16", 3,000 lbs. WLL	24, 99	50089-36	X-TREME Corner Guards - 36" x 8" x 8" - Made In The USA	18
50013-50	Screw Pin Anchor Shackle - Galvanized, 1/2", 4,000 lbs. WLL	24, 99	50089-48	X-TREME Corner Guards - 48" x 8" x 8" - Made In The USA	18
50013-63	Screw Pin Anchor Shackle - Galvanized, 5/8", 6,500 lbs. WLL	24, 99	50092-10	EZ Winder Web Winder	15
50013-75	Screw Pin Anchor Shackle - Galvanized, 3/4", 9,500 lbs. WLL	24, 99	500-C8-RD	2" x 8' Red Ratchet Strap w/ Twisted Snap Hook	77
50013-88	Screw Pin Anchor Shackle - Galvanized, 7/8", 13,000 lbs. WLL	24, 99	50105-11	Poly Deckboard for LAD System for 24" Beam Center	52
50013-100	Screw Pin Anchor Shackle - Galvanized, 1", 17,000 lbs. WLL	24, 99	50112-10	Single Stud Track Fitting	102
50014-50	Clevis Pin Anchor Shackle - Galvanized, 1/2", 4,000 lbs. WLL	24, 99			
50014-63	Clevis Pin Anchor Shackle - Galvanized, 5/8", 6,500 lbs. WLL	24, 99			
50015-10	Ergo 360 Winch Bar - Standard	13			
50015-20	Ergo 360 Winch Bar - Combination	13			
50015-21	Ergo 360 Winch Bar - Combination Box End	13			
50016-25	Quick Links - Zinc Plated, 1/4", 880 lbs. WLL	24, 99			

INDEX BY PRODUCT NUMBER

50115-10	Series E Track Fitting - Heavy-Duty w/ Round Ring 2,000 lbs. WLL	63, 96	50412-102	Zinc Plated Clevis Pin Kit	23
50115-11	Series E Track Fitting - Heavy-Duty w/ D-Ring 2,000 lbs. WLL	63, 96	50412-103	Zinc Plated Clevis Pin Kit	23
50117-10	Lever Binder Locking Clip	27	50414-30	Vers-A-Deck Beam End Assembly	45
50140-10	EZ Binder Lever Load Binder	26	50414-31	Replacement Vers-A-Deck Foot Assembly	45
50140-11	EZ Binder 6600	26	50418 Series	Vers-A-Deck Track	45
50149-10	Captive Tether Fitting for 310R Track	58	50419 Series	Vers-A-Deck Track	45
50149-11	Non-locking Tether Fitting	58	50420-10	Vers-A-Deck	45
50158-10	Series E Wide Top Decking Beam - 92.9" - 103.8"	59	50420-11	Vers-A-Deck Shorter Low Profile Beam	45
50179-10	2" x 102" Auto Hauler Ratchet Strap w/ Wire Hooks	76	50430-10	Magnetic Flag Holder	72
50179-11	2" x 102" Auto Hauler Ratchet Strap w/ Low Profile Swivel J Hooks	76	50432-10	Fluorescent Mesh Safety Vest, Lime Green	74
50186-10	Wide Top Aftermarket Beam - 97.2" - 108.8"	49	50432-11	Fluorescent Mesh Safety Vest, Orange	74
50186-10-RT	Replacement Tube for 50186-10	49	50434-10	Triangle Warning Kit	74
50187-30	Low Profile Foot and Channel Assembly	48	50433-10	HD Strap Storage Band	15
50187-31	Lift-A-Deck II Foot Assembly	48	50435-L	Work Gloves	74
50188-10	Foot and Channel Assembly for Aftermarket Beams	49	50435-XL	Work Gloves	74
50191-10	Heavy-Duty Aftermarket Beam - 97.3" - 108.8"	49	50435-3T-L	Insulated Work Gloves	74
50191-10-RT	Replacement Tube for 50191-10	49	50435-3T-XL	Insulated Work Gloves	74
50192-14-72.00	LAD Standard Single Track	50	50451-11	Corner Protector Placement Tool	19
50193-30-72.00	Heavy-Duty Beveled Aircraft Style Track 72"	102	50480-100	Knock Down Pallet Deck	54
50194-100	Low Profile Allen Sleeve Nut and Bolt Kit for Beams	49, 60	50486-10	Rubber Beam Stop	45
50199-10	Cargo Net for Short Bed Pickups	86	50514-10	Security Divider & Deckboard, single panel	53
50199-11	Cargo Net for Long Bed Pickups	86	50515-10	Security Divider & Deckboard, Bulkhead Kit, HD Lockable Beams, 2 panels	53
50312-10	Wide Top LAD Beam w/ Reinforced 1-in. Sides	47	50515-11	Security Divider & Deckboard, Bulkhead Kit, STD Lockable Beams, 2 panels	53
50312-10-RT	Replacement Tube for 50312-10	47	50524-10	Lift-A-Deck II High rise foot beam end assembly	48
50354-10	5th Wheel Release Hook	42	50530-10	FasTrack Lift-A-Deck II Conversion Track	51
50360-20	XHD™ Chain Binder 5/16"	27	50530-20	FasTrack Double Track	51
50360-21	XHD™ Chain Binder 3/8"	27	50587-10	Wide Top Low Profile Beam Assembly	51
50362-11	Double Track Fitting	102	52210GL	Goldline EPDM Tarp Ties, 10"- 50 per Box	20
50364-38-10	G70 - XHD™ 3/8" Chain Assembly, 10-ft	22	52210AE	Ankra EPDM Tarp Ties, 10"- 50 per Box	20
50364-38-20	G70 - XHD™ 3/8" Chain Assembly, 20-ft	22	52210C	Natural Rubber Tarp Ties, 10"- 50 per Box	20
50391-10	Premium Cargo Strap Winder	15	52215GL	Goldline EPDM Tarp Ties, 15"- 50 per Box	20
50398-20	Cargo Control Display - Freestanding	103	52215AE	Ankra EPDM Tarp Ties, 15"- 50 per Box	20
50404-10-33	X-TREME Rope Tie Down, 33-ft	41	52215C	Natural Rubber Tarp Ties, 15"- 50 per Box	20
50404-10-36	X-TREME Rope Tie Down, 36-ft	41	52221GL	Goldline EPDM Tarp Ties, 21"- 50 per Box	20
50404-10-40	X-TREME Rope Tie Down, 40-ft	41	52221AE	Ankra EPDM Tarp Ties, 21"- 50 per Box	20
50409-10	Toss 'N Tie	41	52221C	Natural Rubber Tarp Ties, 21"- 50 per Box	20
50410-12	Beam Rack	62			
50412-100	Zinc Plated Clevis Pin Kit	23			

GENERAL INFORMATION

INDEX BY PRODUCT NUMBER

52231GL	Goldline EPDM Tarp Ties, 31"- 50 per Box	20	95001	1" x 8' Cam Straps w/ Vinyl-Coated S Hooks, 2-pack.	84
52231AE	Ancra EPDM Tarp Ties, 31"- 50 per Box	20	95002	1" x 10' Ratchet Straps Vinyl-Coated S Hooks, 2-pack	85
52231C	Natural Rubber Tarp Ties, 31"- 50 per Box	20	95370	1" x 6' Retractable Ratchet Straps w/ Vinyl Coated S Hooks, 2-pack.	85
52241GL	Goldline EPDM Tarp Ties, 41"- 50 per Box	20	95004	1" x 8' Cam Straps w/ Vinyl-Coated S Hooks, 4-pack	85
52241AE	Ancra G4EPDM Tarp Ties, 41"- 50 per Box	20	95005	1" x 10' Ratchet Straps w/ Vinyl-Coated S Hooks, 4-pack	85
52241C	Natural Rubber Tarp Ties, 41"- 50 per Box	20	95007	1" x 12' Endless Ratchet Straps, 2-pack.	85
60169-10	Auxiliary Air Tank Kit.	55	LR0401-01	Fork Lift Stand	103

INDEX BY PRODUCT NAME

Adjuster, 3-Bar Slide	91	Cleat, Single	76	Hooks, Wire	92
Allen Sleeve Nut & Bolt Kit,		Clevis Hooks	23, 98	Hoops, Decking Beam	59
Low Profile	49, 60	Clevis, Twin	25, 100	Jack Bar Component Kits	61
Anchor, Chain	97	Coil Racks	16	Jack Bars	62
AutoDeck	44	Corner Protectors	17, 18	Load Binder	26, 27
Auto Tie Downs	76, 77, 78	Corner Protector Placement Tool	19	Lift-A-Deck II	46, 47, 48, 49, 50, 51
Banners, Safety	73	Deckboard, Security Divider	53	Lift-A-Deck II Straps	51
Bar, Beam Release	48	Deckboard, Security Divider Kit	53	Lift-A-Deck Foot Assembly	48
Bars, Cargo Sta	61	Decking Beam Hoops	59	Lift-A-Deck Poly Deckboard	52
Bars, Jack	62	Decking/Shoring Beams	48, 58, 59, 60	Lifting Slings	78, 79, 80
Bars, Shoring	60	Display, Cargo Control	103	Links, Quick	24, 99
Bars, Winch	12	Dolly Straps	77	Locking Clip, Lever Binder	27
Beam, Foot & Channel Assembly	47, 59	Door Pull Straps	63	Logist-A-Panel	52
Beam Release Bar	48	D-Rings, Forged	14	Merchandising Aids	104
Beam Release Bar Holder	48	Electronic Restraint Straps	67	Mini Ratchet Strap	84
Beam Replacement Tube	48	Ergo 360 Winch Bars	13	Nets, Cargo	86
Beam Sockets	60	EZ Binder	26	Nets, Custom	70
Beam Stop, Rubber	45, 48	EZ Winder	15	Overcenter Buckles	90
Beams, Decking/Shoring	48, 58, 59, 60	Fastrack LAD II Conversion Track	51	Pallet Deck	54
Binders, Chain Load	26, 27	Fittings, Pan	64	Pan Fittings	64
Binder, Ratchet	27	Fittings, Track	631, 96, 97, 102	Poly Deckboard, LAD	52
Binder, Recoilless	26	Flag, Safety	72	Poly Deckboard Calculator	70
Bolt Plates	95	Flat Hooks	93	Plate Trailer Straps	68, 69
Buckle, Roller	91	Flat Latch Repair Kit	60	Plates, Bolt	95
Buckles, Cam	91	Floor Chain Tie Down	27	PortaAnchor	9
Buckles, Overcenter	90	Foot & Channel Assembly, Low Profile	47	PortaWinch	9
Buckles, Ratchet	88, 89, 90	Fork Lift Stand	103	Protectors, Corner	17, 18
Cable Assemblies	41	GlideLock	16	Protector, Tarp	17
Cam Buckle Strap		Gloves, Reflective Work	74	Protectors, Web	17
Assemblies	51, 67, 68, 85	Goldline EPDM Tarp Ties	20	Ratchet Buckle Strap	
Cam Buckles	91	Grab Hook Assembly	98	Replacements	39, 40
Cargo Bar Holder	63	HD Strap Storage Band	20	Ratchet Buckle Strap, Series E	66, 67
Cargo Nets	70, 86	Hook, Clevis	23, 98	Ratchet Strap	
Cargo Sta	61	Hook, Container	91	Assemblies	34-40, 51, 66, 69, 84
Cargo Sta Replacements	61	Hook, Corner Iron	15	Ratchet Strap Assy, Web Keeper	38
Cart Securement System	53	Hook, Double L Track Slider	15	Ratchet Strap, Mini	85
Chain	21, 22	Hook, Grab	98	Ratchet Buckles	88, 89, 90
Chain Anchor	97	Hook, H-2	15	Ratcheting Cap, OverDrive	12
Chain Assemblies	21, 22	Hook, Rave	92	Reflectors	74
Chain Attachments	24, 25, 95, 97, 98, 99, 100	Hook, RTJ Cluster	98	Release Hook, 5th Wheel	42
Chain Binder, Lever	26	Hook, Rubber Rope	20	Retract-A-Roll	55
Chain Binder, Ratchet	27	Hook, S	92	Rings	94
Chain Binder, Recoilless	26	Hook, Swivel J	97	Rings, Delta	94
Chain Binder, Safety Clip	27	Hook, Tarp	15	Roll-On/Roll-Off Container Straps	33
Chain Binder, XHD	27	Hooks, Flat	93	Roller Buckle	91
Chain Hardware	24, 25, 99, 100	Hooks, Slip	25, 94, 100	Rope Tie Down, X-TREME	41
Channel Assembly,		Hooks, Snap	94	Rope Tie Offs	63
Replacement	48, 49, 60	Hooks, Waste	93	Rope, Rubber	20

INDEX BY PRODUCT NAME

RTJ Cluster Hook	98	Strap, Trailer Door Limit	65	Track Stop, Steel Beam	48
Rubber Rope	20	Straps, Cam Buckle	51, 67, 68, 84, 85	Track, Series A	57
Rubber Rope Hook	20	Straps, Container	33	Track, Series E	56
Safety Vests	74	Straps, Dolly	77	Track, Series F	57
Series A Track	57	Straps, Driver Assist	65	Track, Series F Channel	58
Series E Heavy-Duty Strap	66	Straps, Door Pull	63	Triangle Warning Kit	74
Series E Ratchet Buckle Strap	66, 69	Straps, Electronic	68	Truck & Trailer Fittings (pan, anchor)	64
Series E Track	56	Straps, Plate Trailer	67, 68	Van Trailer Bracket Kit	19
Series E Transit Strap	77	Straps, Ratchet		Vers-A-Deck	45
Series F Channel Track	58	Buckle	34–40, 66, 69, 76, 77, 84	Utility Strap	84
Series F Track	57	Straps, Series F	67	Web Protectors	17
Shackles	24, 99	Straps, Tension Limiting Ratchet	66	Web Winder	15
Shoring Bar - F Series	60	Straps, Transit w/ RTJ Hooks	77	Webbing	101
Signs, Safety	73	Straps, Utility	84	Winch Bars	14
Ankra EPDM Tarp Ties	20	Straps, Winch	28, 29, 30, 31, 32, 33, 76	Winch Straps	28, 29, 30, 31, 32, 33, 76
Slings, Eye to Eye Web	81, 82	Tarp Protector	17	Winch Track	11
Slings, Round	80	Tarp Ties	20	Winches Web	2, 3, 4, 5, 6
Slip Hooks	25, 98, 100	Tension Limiting Ratchet Assemblies	66	Winch, Cable	7
SilverCap OverDrive Ratcheting Cap	12	Tether Track	58	Winches, Combination	7
Snap Hooks	94	Tie Downs, Auto	76, 77	Winches, Lashing	8, 78
Stake Pocket Anchor	64	Tie Downs, Cam Buckle Packaged	85	Winches, PortaWinch, PortaAnchor	9
Strap, Ancra Lash	84	Tie Downs, Floor Chain	27	Winches, Sliders	3, 4, 5
Strap, Ratchet		Tie Downs, Ratcheting Packaged	84, 85	Winder, Web	15
Assembly	34–40, 51, 66, 69, 84, 85	Tie Offs	63	Winder Strap	15
Strap, Cam Buckle		Ties, Tarp	20	Wire Hooks	92
Assembly	51, 67, 68, 84, 85	Tire Bonnets	78	Winches, 3-Bar	6
Strap, Lift-A-Deck II Assemblies	51	Toss 'N Tie	41	X-TREME Guard Corner Protector	18
Strap, Mini Ratchet	85	Track, Lift-A-Deck II	50, 51	X-TREME Rope Tie Down	41
Strap, Series E	66	Track, Aircraft	102	X-TREME Winch Strap,	
Strap, Series E Transit	77	Track End Caps	57	Assemblies	28, 29, 30, 33, 34, 35, 38, 39
Strap, Storage Band	20	Track Fittings	63, 96, 97, 102		
Strap, Trailer Door, Releasable	64	Track, Heavy-Duty	102		

CALIFORNIA PROPOSITION 65

What is Proposition 65 and how does it affect Ancra Cargo?

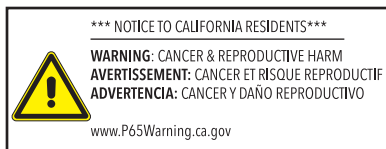

On August 31, 2018, the State of California enacted regulations that require products be marked at point of sale containing chemicals from a list of over 300 that can potentially cause cancer or reproductive harm. Ancra will comply with these regulations with the addition of Prop 65 labels to our products that contain any of these harmful substances.

Proposition 65 is a broad law that applies to any company operating in California, selling products in California, or manufacturing products that may be sold in, or brought into, California. Proposition 65 mandates that the Governor of California maintain and publish a list of chemicals that are known to cause cancer, birth defects and/or other reproductive harm. The list, which must be updated annually, includes a wide variety of chemicals that can be found in many everyday items, such as dyes, solvents, drugs, food-additives, by-products of certain processes, pesticides, and tobacco products.

The purpose of Proposition 65 is to ensure that people are informed about exposure to these chemicals. Proposition 65 also requires warnings to be placed on any product, product packaging, or literature accompanying a product that contains or may contain any of the more than 800 chemicals that the California Air Resources Board considers harmful. As noted above, many of the elements listed under Proposition 65 have been routinely used in everyday consumer items for years without documented harm.

LETTER FROM ANCRA CARGO



Dear Ancra Community,

Welcome to the latest edition of the Ancra Cargo catalog!

Thank you for paging through the entire catalog. As Ancra Cargo celebrates over 50 years of service to the transportation industry, we would like to take this opportunity to thank you for participating in our success. We pride ourselves on being the Leader in Load Securement Innovation and this would not be possible without our valued customers and the support of our dedicated team.

Ancra Cargo acknowledges our customers, distributors, suppliers, and employees for their partnerships as we continue always moving forward into the future, leading the way in cargo securement together.

Our mission is to remain the world-class leader in cargo handling and restraint systems by providing quality products on time with the greatest value to our customers. We are focused on our customers, meeting and striving to exceed your expectations for years to come.

We promise, through the use of superior design, quality materials and attention to detail, Ancra Cargo's advanced engineering capabilities will continue to raise product performance to a new level for the next 50 years.

Sincerely,

Employees of Ancra Cargo



CARGO SYSTEMS DIVISION HEADQUARTERS

Ancra Cincinnati

1655 Worldwide Blvd., Hebron, KY 41048

Phone: 1-859-371-7272

Phone Toll Free: 1-800-233-5138

Fax: 1-859-371-4367

Fax Toll Free: 1-800-347-2627

E-mail: cargo-sales@ancra.com

WAREHOUSE / SHIPPING FACILITIES

Ancra Cincinnati

Hebron, KY 41048

Pacific Northwest

Accord Distributors

9822 47th Avenue SW, Lakewood, WA 98449

Southwest

301 VZ County Road 1117, Grand Saline, TX 75140

Ancra Canada

520 Beard Lane, Suite A

Woodstock, Ontario N4S 7W3

Phone: 1-519-937-9170

Phone Toll Free: 1-866-962-0055

Fax: 1-519-602-0980

Fax Toll Free: 1-866-792-0058

E-mail: cargo-salescanada@ancra.com

